

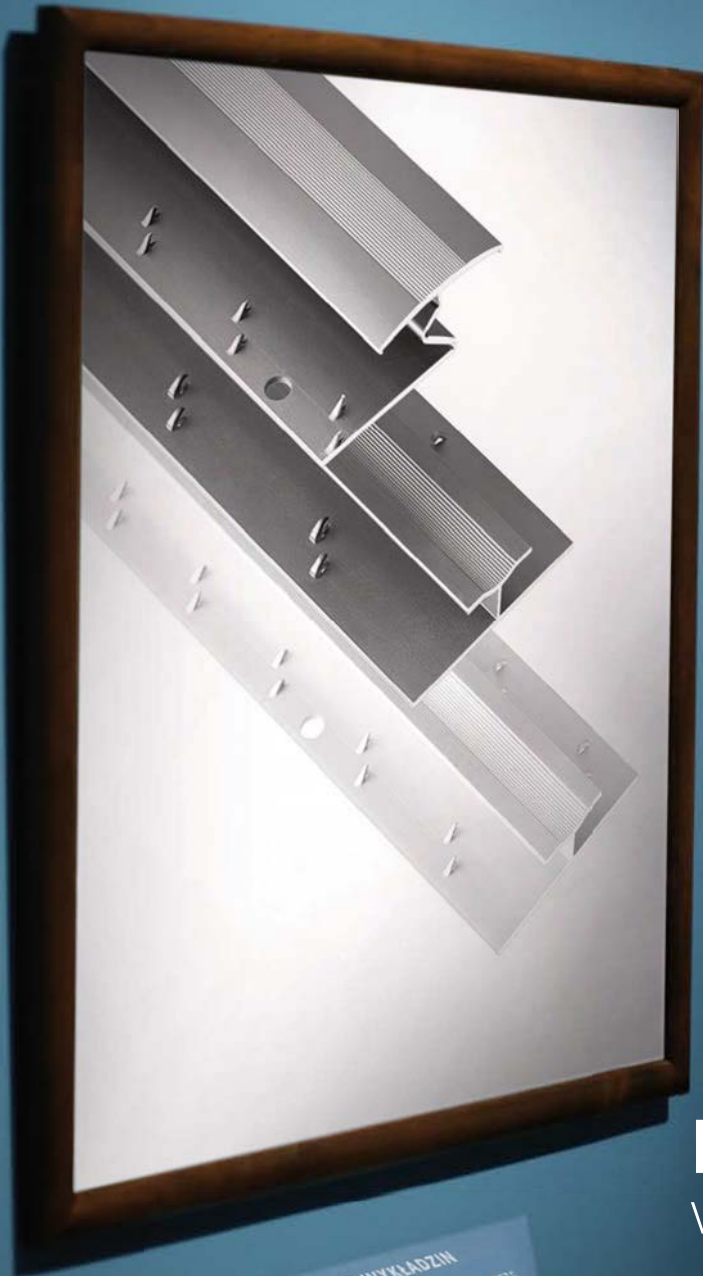

# EFFECTOR

aluminium i szkło



PROFILE DO WYKŁADZIN  
I DYWANÓW  
PROFILES FOR FLOOR COVERINGS AND CARPETS

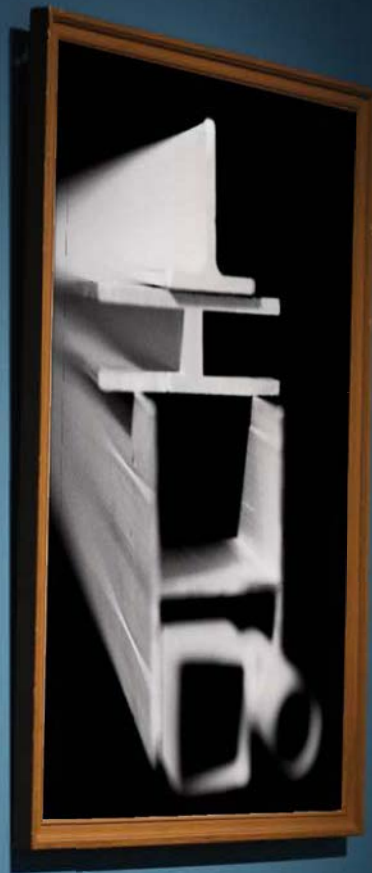

WZSTĄPCZNIKA  
DLA MASYWNOŚCIZÓW  
WYPROLES



**Listwy**  
wykończeniowe  
i **elementy**  
aranżacji wnętrza

**Finishing** profiles  
and elements  
of interior design

# SPIS TREŚCI

TABLE OF CONTENTS | INHALTSÜBERSICHT

8

## STANDARD – LISTWY WYKOŃCZENIOWE

FINISHING PROFILES | ABSCHUßPROFILE

12

listwy łączeniowe  
joining strips | Übergangsprofile

18

listwy dylatacyjne  
dilatation strips | Dehnungsprofile

20

kątowniki  
angle bars | Winkelprofile

28

listwy wykończeniowe  
finishing strips | Abschlußprofile

30

## MULTI – LISTWY PRZYPODŁOGOWE

SKIRTING BOARDS | SOCKELLEISTEN

38

## IMPRESJA – PROFILE DO GLAZURY I TERAKOTY

PROFILES FOR TILES | FLIESENPROFILE

48

## BOA – PROFILE WYKOŃCZENIOWE GIĘTE

BENDABLE FINISHING PROFILES | BIEGELEISTEN

54

## EASY – KSZTAŁTOWNIKI DLA MAJSTERKOWICZÓW

DIY PROFILES | BASTLERPROFILE

62

## FANTAZJA – PROFILE BUDOWLANE PVC

PVC DIY PROFILES | DIE KUNSTOFFBAUPROFILLE

# PIKTOGRAMY

PICTOGRAMS | PIKTOGRAMME

**AI**

## LISTWA ALUMINIOWA

Aluminium strip  
Aluminiumleiste

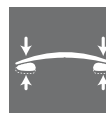

## LISTWA Z USZCZELKĄ SILIKONOWĄ

Strip with silicone gasket  
Leiste mit Silikondichtung

**PVC**

## LISTWA Z PVC

PVC strip  
Leisten aus PVC



## LISTWA LAKIEROWANA

Lacquered strip  
Lackierte Leiste

**ANODA**

## LISTWA Z POWŁOKĄ ANODOWANĄ

Strip with anodized coating  
Leiste mit Aluminiumschicht



## LISTWA PRZYKRĘCANA

Screwed strip  
Leiste angeschraubte



## LISTWA OKLEINOWANA

Laminated strip  
Leiste mit Furnier



## LISTWA SAMOPRZYLEPNA

Self-adhesive strip  
Leiste selbstklebend

**+**

## LISTWA ELEKTROPOLEROWANA

Electropolished strip  
Elektropolierte leiste



## LISTWA SZYBKIEGO MONTAŻU

Quick instalation strip  
Leiste, easy fix



## LISTWA Z ZACZEPAMI DO WYKŁADZIN I DYWANÓW

Strip with fastenings to floor coverings and carpets  
Leiste mit Haken zu den Bodenbelägen und den Teppichen



## LISTWA WYKOŃCZENIOWA GIĘTA

Finishing bendable strip  
Biegeleisten

**\***

**ZAM**

## PRODUKT DOSTĘPNY NA ZAMÓWIENIE

(ilości ustalane indywidualnie)

Product available on request  
Nur auf Bestellung

**WOOD  
-LOOK**

## WOOD-LOOK

The product is available in Wood-look colors  
Das Produkt ist in Wood-Look erhältlich

# O NAS

Effector S.A. działa w branży budowlanej od trzydziestu lat, nieustannie pasjonując się możliwościami, które daje zaawansowana technologia w połączeniu z właściwościami aluminium i innych materiałów, służących do dekoracji wnętrz.

Swoją pozycję zawdzięczamy przede wszystkim inwestycjom w innowacyjne technologie, chroniące środowisko naturalne oraz nieustannemu doskonaleniu jakości produktów.

Nasze kolekcje profili wykończeniowych z aluminium oraz PVC to doskonałe rozwiązania, umożliwiające estetyczne, a zarazem funkcjonalne wykończenie podłóg laminowanych, drewnianych, wykonanych z glazury, terakoty, wykładziny oraz innych materiałów. Listwy wyróżniają się różnorodnością sposobów montażu, dostępnością dodatkowych akcesoriów, bogactwem kolorystyki aluminium anodowanego i oklein drewnopodobnych.





# ABOUT US



Effector S.A. has been active in the construction industry for thirty years, constantly passionate about the possibilities offered by advanced technology combined with the properties of aluminium and other materials used for interior decoration.

We owe our position primarily to investments in innovative technologies that protect the natural environment as well as continuous improvement of product quality.

Our collections of aluminium and PVC finishing strips are the perfect solutions for an aesthetic and functional finish of laminated or wooden floors, as well as those made of ceramic tiles, gres, covered with carpets and other materials. The strips are distinguished by a variety of installation methods, the availability of additional accessories, a rich colour range of anodized aluminium and wood-like veneers.



# EKOLOGIA

W Effector S.A. dbamy o każdy, najdrobniejszy szczegół podczas powstawania listew wykończeniowych, bo to jeden z istotnych detali, decydujący o charakterze każdego pomieszczenia. W centrum naszych zainteresowań jest człowiek, a jego potrzeby i wartości wyznaczają kierunki rozwoju naszej marki.

Dlatego właśnie tak duże znaczenie przywiązujemy do ekologii i optymalizujemy nasze procesy produkcyjne oraz redukujemy wpływ na środowisko. Stosujemy Zintegrowany System Zarządzania, obejmujący system zarządzania Jakością i Środowiskiem z serii ISO 9001 / ISO 14001.

Konsekwentnie wyznaczamy sobie coraz to nowe cele i dążymy do ich osiągnięcia. Nasze zadania to m.in. właściwe zarządzanie energią, segregacja odpadów, dbanie o czystość powietrza atmosferycznego.

Prowadzimy także kampanie informacyjne zachęcające do świadomych, proekologicznych zachowań, takich jak zrównoważony rozwój i podejmowanie działań w celu minimalizowania własnego wpływu na środowisko naturalne.





# ECOLOGY



In Effector S.A. we take care of every smallest detail when creating the finishing strips, because it is one of the important elements that determines the character of each room. People are at the center of our interests, and their needs and values set the directions for the development of our brand.

That is why we attach so much importance to ecology, optimize our production processes and reduce the impact on the environment. We use the Integrated Management System, including the ISO 9001 / ISO 14001 series of quality and environmental protection management.

We consistently set new goals and strive to achieve them. Our tasks include i.a. proper energy management, waste segregation, taking care of clean atmospheric air.

We also run information campaigns encouraging conscious, pro-ecological behaviours, such as sustainable development and taking actions to minimize our own impact on the natural environment.



# Listwy wykończeniowe





# Finishing profiles

# STANDARD

listwy **łączeniowe**  
joining strips

listwy **dylatacyjne**  
dilatation strips

**kątowniki**  
angle bars

listwy **wykończeniowe**  
finishing strips



BEZPIECZEŃSTWO  
SAFETY



TRWAŁOŚĆ  
DURABILITY



ELEGANCJA  
ELEGANCE



BOGATA GAMA  
KOLORYSTYCZNA  
COLORFUL



NOWOCZESNY  
DESIGN  
MODERN DESIGN



EKSPRESOWY  
MONTAŻ  
QUICK MOUNT



PRODUKT POLSKI  
POLISH PRODUCT



ODPORNOŚĆ  
NA ZARYSOWANIA  
SCRATCH RESISTANT



PRZYJAZNE  
ŚRODOWISKU  
ECO-FRIENDLY



BEZ ZAWARTOŚCI  
OŁOWIU  
LEAD FREE

# ALUMINIUM ANODOWANE

ANODISED ALUMINIUM | ALUMINIUM ELOXIERT

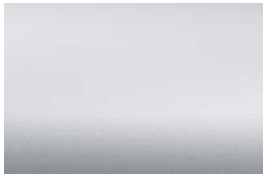

**01** SREBRO  
SILVER  
SILBER



**71** INOX GŁADKI  
INOX SMOOTH  
INOX GLATT



**07** INOX SZCZOTKOWANY  
BRUSHED INOX  
GEBÜRSTET INOX



**00** ZŁOTO  
GOLD  
GOLD



**002** ZŁOTO PIASKOWANE  
GOLD SAND  
SANDGOLD



**02** SZAMPAN  
CHAMPAGNE  
CHAMPAGNE



**04** OLIWKA  
OLIVE  
OLIVE

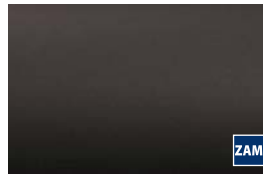

**03** BRAZ  
BROWN  
BRAUN

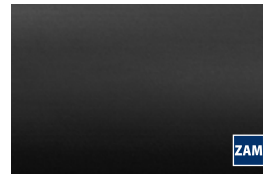

**005** CZARNY  
BLACK  
SCHWARZ

# ALUMINIUM OKLEINOWANE

VENEERED ALUMINIUM | ALUMINIUM UMMANTELT



**28** BUK JASNY  
LIGHT BEECH  
BUCHE HELL



**08** BUK  
BEECH  
BUCHE



**20916** DĄB BIAŁY  
RAW OAK  
EICHE WEIB



**20901** DĄB BIELONY  
WHITE OAK  
EICHE GEBLEICHT



**20918** DĄB BERGERAC  
BERGERAC OAK  
EICHE BERGERAC



**20917** DĄB JAŚMINOWY  
JASMINE OAK  
EICHE JASMIN



**20915** DĄB WANILIA  
VANILLA OAK  
EICHE VANILLE



**20913** DĄB MALAGA  
MALAGA OAK  
EICHE MALAGA



**20919** DĄB SZARY  
GRAY OAK  
EICHE GRAUE



**20902** DĄB MOCCA  
MOCCA OAK  
EICHE MOCCA



**20912** DĄB TABACCO  
TABACCO OAK  
EICHE TABACCO



**20904** DĄB ARCTIC  
ARCTIC OAK  
EICHE ARCTIC

## ALUMINIUM OKLEINOWANE

VENEERED ALUMINIUM | ALUMINIUM UMMANTELT



**20920** DĄB NATURALNY  
NATURAL OAK  
EICHE NATUR

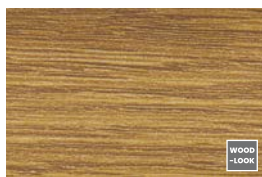

**20921** DĄB LEMON  
LEMON OAK  
EICHE LEMON



**20908** DĄB PIWNY  
BERY OAK  
EICHE HELLBRAUN



**29** DĄB JASNY  
LIGHT OAK  
EICHE HELL



**20907** DĄB PIĄSKOWY  
SANDY OAK  
EICHE SAND

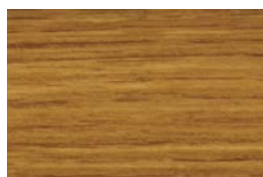

**20906** DĄB KONIAKOWY  
COGNAC OAK  
EICHE COGNAC

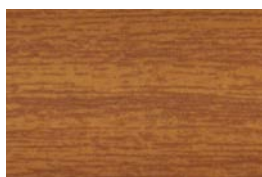

**20905** DĄB BURSZTYNOWY  
AMBER OAK  
EICHE BERNSTEIN



**20903** DĄB ANTYCZNY  
ANTIQUO OAK  
EICHE ANTIK



**20914** DĄB TOPAZ  
TOPAZ OAK  
EICHE TOPAS

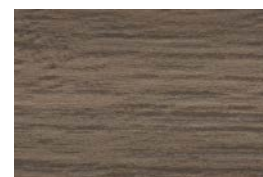

**20911** DĄB VERDEN  
VERDEN OAK  
EICHE VERDEN

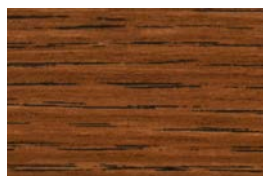

**20910** DĄB ZAMKOWY  
CASTLE OAK  
SCHLOSS EICHE

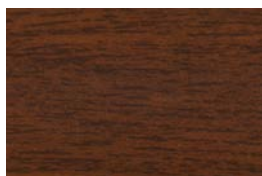

**0909** DĄB ŻŁÓCISTY  
GOLDEN OAK  
EICHE GOLD



**09** DĄB  
OAK  
EICHE

NIE WYSTĘPUJE  
NOT AVAILABLE  
NICHT VERFÜGBAR

**E31, E33, E64, E66, E68**

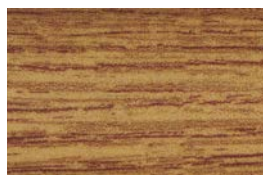

**34** WIĄZ  
ELM  
ULME

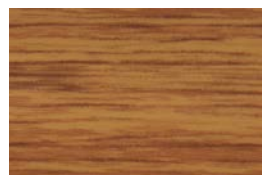

**32** HIKORA  
HICKORY  
HIKORYBAUM

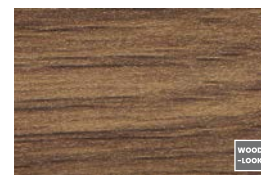

**20922** ORZECH SIENNA  
SIENNA NUT  
SIENNE NUSS



**2701** ORZECH CHILE  
CHILE NUT  
NUSSBAUM CHILE



**20944** MERBAU  
MERBAU  
MERBAU

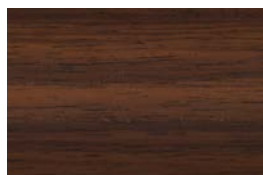

**4500** TEAK INDYJSKI  
INDIAN TEAK  
INDISCHER TEAK



**33** AFREZJA  
AFREZY  
AFREZY



**3101** KASZTAN JAPONSKI  
JAPANESE CHESTNUT  
JAPANISCHE KASTANIE

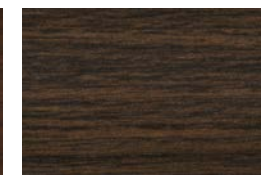

**4201** WENGE KONGO  
CONGO WENGE  
WENGE KONGO



LISTWA ŁĄCZENIOWA

A02



JOINING STRIP  
ÜBERGANGSLEISTE

DŁUGOŚĆ [m] Length   Länge	0,93	1,2 *	1,8	2,7	3,6 *
-------------------------------	------	-------	-----	-----	-------

LISTWA ŁĄCZENIOWA

A03



JOINING STRIP  
ÜBERGANGSLEISTE

DŁUGOŚĆ [m] Length   Länge	0,93	1,2 *	1,8	2,7	3,6 *
-------------------------------	------	-------	-----	-----	-------

LISTWA ŁĄCZENIOWA

A04



JOINING STRIP  
ÜBERGANGSLEISTE

DŁUGOŚĆ [m] Length   Länge	0,93	1,2 *	1,8	2,7	3,6 *
-------------------------------	------	-------	-----	-----	-------

LISTWA ŁĄCZENIOWA

A08



JOINING STRIP  
ÜBERGANGSLEISTE

DŁUGOŚĆ [m] Length   Länge	0,93	1,2 *	1,8	2,7	3,6 *
-------------------------------	------	-------	-----	-----	-------



## LISTWA PROGOWA Z WKŁADKĄ ANTYPOŚLIZGOWĄ (GUMA)

SILL STRIP WITH ANTI-SLIP INSERT (RUBBER)  
SCHWELLENLEISTE MIT ANTI-RUTSCH EINSATZ (GUMMI)

DŁUGOŚĆ [m]  
Length | Länge

0,93	1,2*	1,8	2,7	3,6*
------	------	-----	-----	------

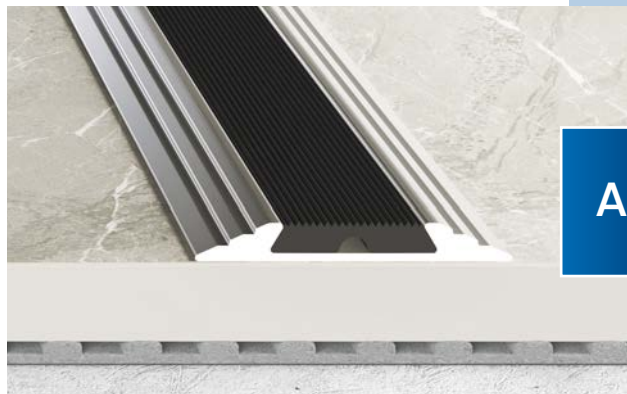
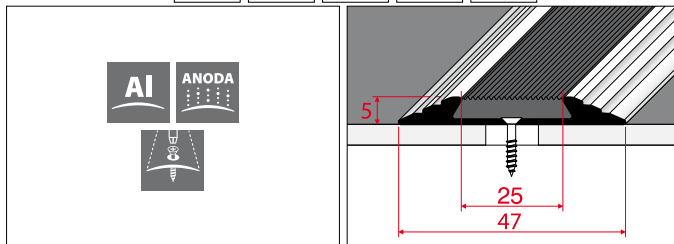

A10

## GUMA ANTYPOŚLIZGOWA DO LISTWY A10

NON-SLIP RUBBER A10  
ANTI-RUTSCH-GUMMI A10

KOLORY GUMY A10G  
RUBBER COLOURS  
FARBEN



88 CZARNY  
BLACK  
SCHWARZ



A10G

## LISTWA ŁĄCZENIOWA

JOINING STRIP  
ÜBERGANGSLEISTE

DŁUGOŚĆ [m]  
Length | Länge

0,93	1,8	2,7	3,6*
------	-----	-----	------

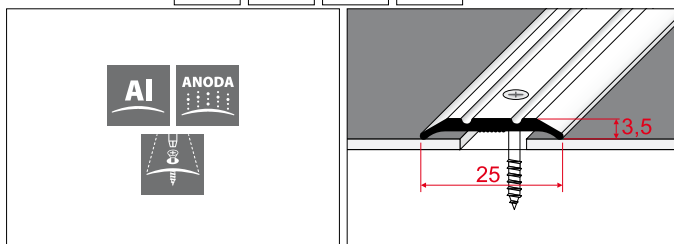

A12

## LISTWA ŁĄCZENIOWA

JOINING STRIP  
ÜBERGANGSLEISTE

DŁUGOŚĆ [m]  
Length | Länge

0,93	1,8	2,7	3,6*
------	-----	-----	------

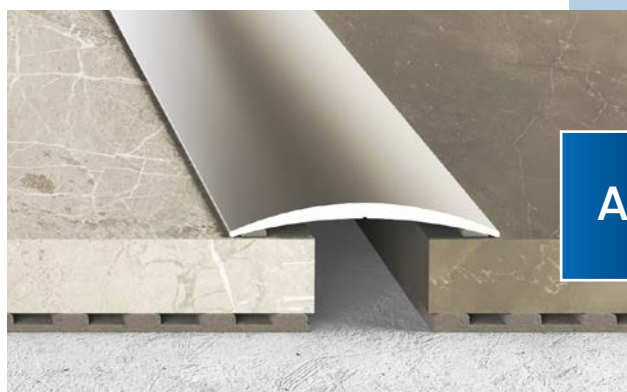
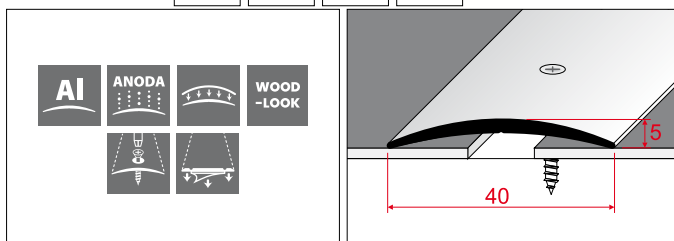

A13

LISTWA PROGOWA ŁĄCZENIOWA

A61

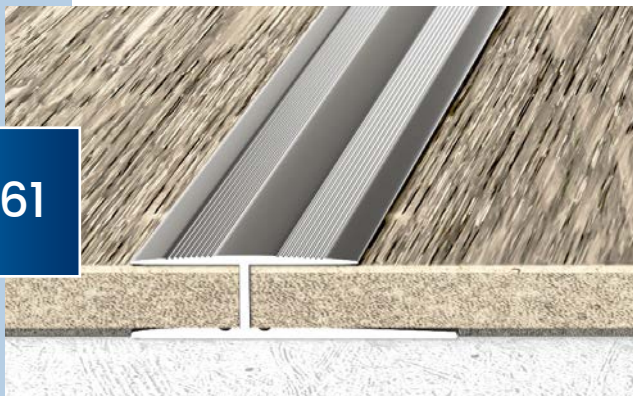

JOINING SILL STRIP  
ÜBERGANGSLEISTE

DŁUGOŚĆ [m] Length   Länge	0,9	1,2*	1,8	2,7	3,6*
-------------------------------	-----	------	-----	-----	------

AI

ANODA

ZAM

LISTWA SZYBKIEGO MONTAŻU Z USZCZELKĄ SILIKONOWĄ

A64



QUICK-MOUNTED STRIP WITH SILICONE SEAL  
LEISTE MIT SILIKONDICHTUNG, EASY FIX

DŁUGOŚĆ [m] Length   Länge	0,93	1,2*	1,8	2,7	3,6*
-------------------------------	------	------	-----	-----	------

AI

ANODA

WOOD-LOOK

LISTWA SZYBKIEGO MONTAŻU Z USZCZELKĄ SILIKONOWĄ

A66



QUICK-MOUNTED STRIP WITH SILICONE SEAL  
LEISTE MIT SILIKONDICHTUNG, EASY FIX

DŁUGOŚĆ [m] Length   Länge	0,93	1,2*	1,8	2,7	3,6*
-------------------------------	------	------	-----	-----	------

AI

ANODA

WOOD-LOOK

LISTWA SZYBKIEGO MONTAŻU

A68

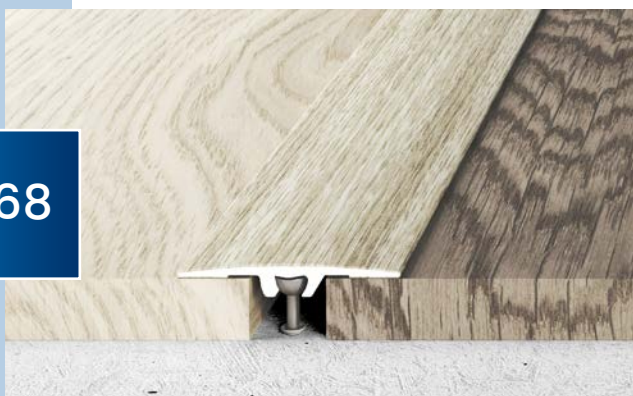

QUICK-MOUNTED STRIP  
LEISTE, EASY FIX

DŁUGOŚĆ [m] Length   Länge	0,9	1,2*	1,8	2,7	3,6*
-------------------------------	-----	------	-----	-----	------

AI

ANODA

LISTWA ZACISKOWA

CLAMPING STRIP  
KLEMMLEISTE

DŁUGOŚĆ [m]  
Length | Länge

0,9

1,2 \*

1,8

2,7

3,6 \*

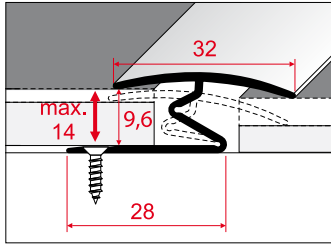

A69

LISTWA ŁĄCZENIOWA

JOINING STRIP  
ÜBERGANGSLEISTE

DŁUGOŚĆ [m]  
Length | Länge

1,0

2,0

3,0

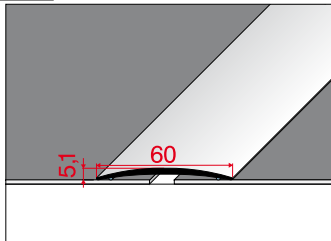
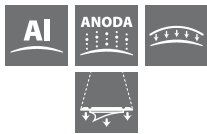

A70

LISTWA ŁĄCZENIOWA

JOINING STRIP  
ÜBERGANGSLEISTE

DŁUGOŚĆ [m]  
Length | Länge

1,0

2,0

3,0

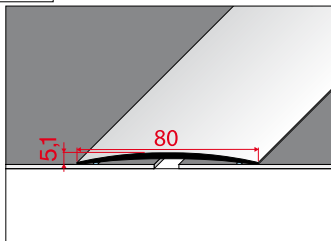
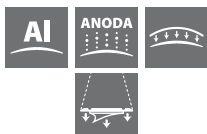

A71

LISTWA ŁĄCZENIOWA

JOINING STRIP  
ÜBERGANGSLEISTE

DŁUGOŚĆ [m]  
Length | Länge

1,0

2,0

3,0

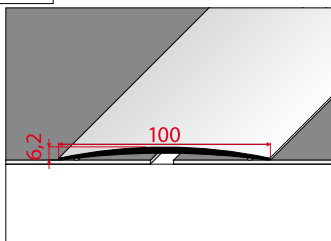

A72



LISTWA ŁĄCZENIOWA

A73



JOINING STRIP  
ÜBERGANGSLEISTE

DŁUGOŚĆ [m]  
Length | Länge

1,0	2,0	3,0
-----	-----	-----

LISTWA ŁĄCZENIOWA

A76



JOINING STRIP  
ÜBERGANGSLEISTE

DŁUGOŚĆ [m]  
Length | Länge

1,0
-----

LISTWA ŁĄCZENIOWA

A77



JOINING STRIP  
ÜBERGANGSLEISTE

DŁUGOŚĆ [m]  
Length | Länge

1,0
-----

PROFIL ŁĄCZENIOWY

C68



JOINING PROFILE  
ÜBERGANGSPROFIL

DŁUGOŚĆ [m]  
Length | Länge

1,0	2,0	3,0
-----	-----	-----



PROFIL ZACISKOWY

CLAMPING PROFILE  
KLEMMPROFIL

DŁUGOŚĆ [m]  
Length | Länge

1,0	2,0	3,0
-----	-----	-----

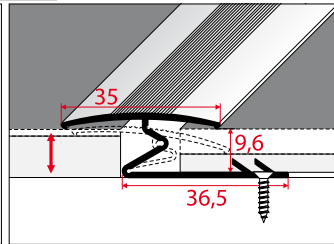
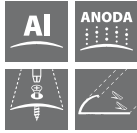

C69

LISTWA SZYBKIEGO MONTAŻU Z KLEJEM

QUICK-MOUNTED BAR SELF-ADHESIVE  
LEISTE, EASY FIX SELBSTKLEBEND

DŁUGOŚĆ [m]  
Length | Länge

1,0	2,0
-----	-----

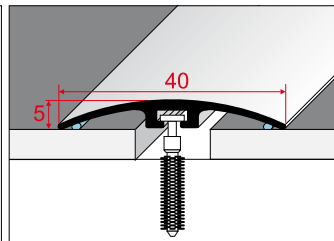

E64

LISTWA SZYBKIEGO MONTAŻU Z KLEJEM

QUICK-MOUNTED BAR SELF-ADHESIVE  
LEISTE, EASY FIX SELBSTKLEBEND

DŁUGOŚĆ [m]  
Length | Länge

1,0	2,0
-----	-----

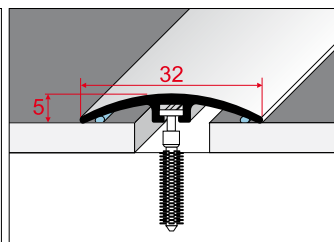

E66

LISTWA SZYBKIEGO MONTAŻU

QUICK-MOUNTED BAR  
LEISTE, EASY FIX

DŁUGOŚĆ [m]  
Length | Länge

1,0	2,0
-----	-----

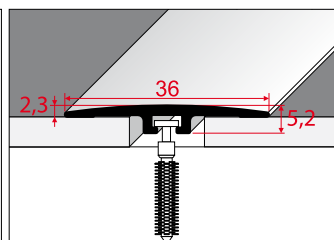

E68

KAŹTOWNIK DYLATACYJNY 15 X 37

A39



DILATATION ANGLE  
ABSCHLUSSPROFIL

DŁUGOŚĆ [m] Length   Länge	0,9	1,2*	1,8	2,7	3,6*
-------------------------------	-----	------	-----	-----	------

LISTWA DYLATACYJNA SAMOPRZYLEPNA

A47



DILATATION STRIP SELF-ADHESIVE  
DEHNUNGSLEISTE SELBSTKLEBEND

DŁUGOŚĆ [m] Length   Länge	0,9	1,2*	1,8	2,7	3,6*
-------------------------------	-----	------	-----	-----	------

LISTWA NAJAZDOWA

A48



APPROACHING STRIP  
AUSGLEICHSLEISTE

DŁUGOŚĆ [m] Length   Länge	1,0	2,0	3,0
-------------------------------	-----	-----	-----

LISTWA NAJAZDOWA

A49



APPROACHING STRIP  
AUSGLEICHSLEISTE

DŁUGOŚĆ [m] Length   Länge	1,0	2,0	3,0
-------------------------------	-----	-----	-----



LISTWA DYLATACYJNA

DILATION STRIP  
DEHNUNGSLEISTE

DŁUGOŚĆ [m]  
Length | Länge

0,9	1,2 *	1,8	2,7	3,6 *
-----	-------	-----	-----	-------

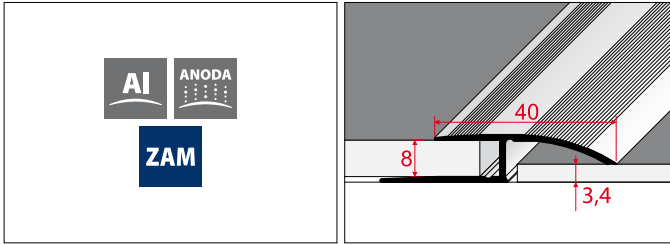

A62

LISTWA DYLATACYJNA SZYBKIEGO MONTAŻU Z USZCZELKĄ SILIKONOWĄ

QUICK-MOUNTED DILATION STRIP WITH SILICONE SEAL  
LEISTE MIT SILIKONDICHTUNG, EASY FIX

DŁUGOŚĆ [m]  
Length | Länge

0,93	1,2 *	1,8	2,7	3,6 *
------	-------	-----	-----	-------

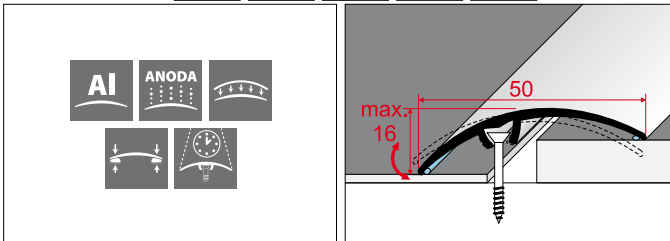

A65

LISTWA DYLATACYJNA SZYBKIEGO MONTAŻU Z USZCZELKĄ SILIKONOWĄ

QUICK-MOUNTED DILATION STRIP WITH SILICONE SEAL  
LEISTE MIT SILIKONDICHTUNG, EASY FIX

DŁUGOŚĆ [m]  
Length | Länge

0,93	1,2 *	1,8	2,7	3,6 *
------	-------	-----	-----	-------

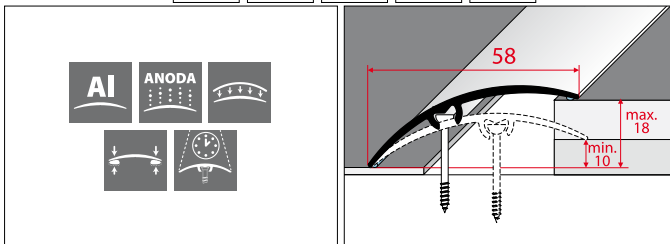

A75



**KĄTOWNIK 20 X 20**

**A30**



ANGLE BAR  
WINKELPROFIL

DŁUGOŚĆ [m] Length   Länge	0,9	1,2*	1,8	2,7	3,6*
-------------------------------	-----	------	-----	-----	------

**KĄTOWNIK 25 X 10**

**A31**



ANGLE BAR  
WINKELPROFIL

DŁUGOŚĆ [m] Length   Länge	0,9	1,2*	1,8	2,7	3,6*
-------------------------------	-----	------	-----	-----	------

**KĄTOWNIK 65 X 42**

**A32**



ANGLE BAR  
WINKELPROFIL

DŁUGOŚĆ [m] Length   Länge	0,9	1,2*	1,8	2,7	3,6*
-------------------------------	-----	------	-----	-----	------

**KĄTOWNIK 40 X 20**

**A33**



ANGLE BAR  
WINKELPROFIL

DŁUGOŚĆ [m] Length   Länge	0,9	1,2*	1,8	2,7	3,6*
-------------------------------	-----	------	-----	-----	------



KAŹOWNIK 35 X 35

ANGLE BAR  
WINKELPROFIL

DŁUGOŚĆ [m]  
Length | Länge

0,9

1,2 \*

1,8

2,7

3,6 \*

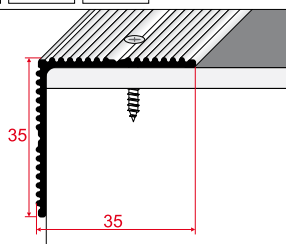
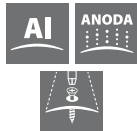

A34

KAŹOWNIK 20 X 20

ANGLE BAR  
WINKELPROFIL

DŁUGOŚĆ [m]  
Length | Länge

0,9

1,2 \*

1,8

2,7

3,6 \*

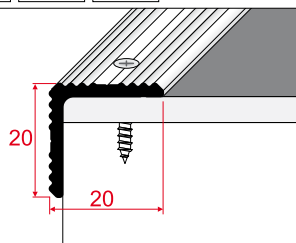
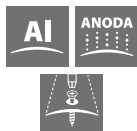

A35

KAŹOWNIK 25 X 20

ANGLE BAR  
WINKELPROFIL

DŁUGOŚĆ [m]  
Length | Länge

0,9

1,2 \*

1,8

2,7

3,6 \*

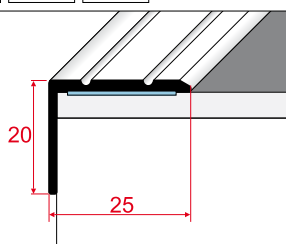

A36

KAŹOWNIK 25 X 25

ANGLE BAR  
WINKELPROFIL

DŁUGOŚĆ [m]  
Length | Länge

0,9

1,2 \*

1,8

2,7

3,6 \*

Anoda - ryflowana. Okleina - gładka.  
Anodized with grooves. Anodized smooth  
Anode gerillt. Anode glatt.

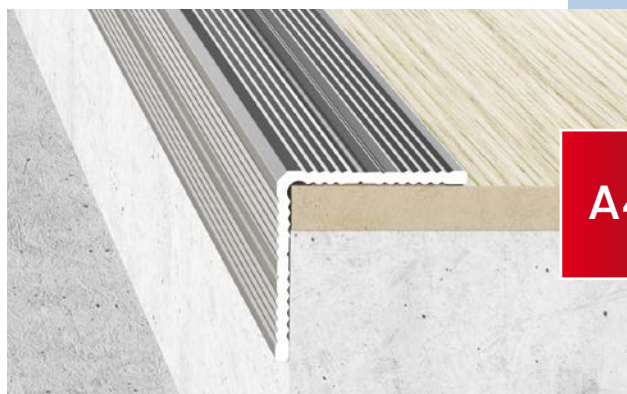
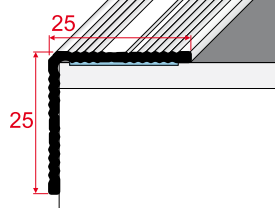
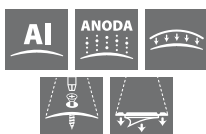

A40

**LISTWA SCHODOWA Z WKŁADKĄ ANTYPOŚLIZGOWĄ**

**A37**



STAIRS SLAT WITH ANTI-SLIP INSERT  
STUFENLEISTE MIT ANTI-RUTSCH-EINSATZ (GUMMI)

DŁUGOŚĆ [m]  
Length | Länge

0,9	1,2*	1,8	2,7	3,6*
-----	------	-----	-----	------

**GUMA ANTYPOŚLIZGOWA DO LISTWY A37**

**A37G**



NON-SLIP RUBBER A37  
ANTI-RUTSCH-GUMMI A37

KOLORY GUMY A37G  
RUBBER COLOURS  
FARBEN

**88** CZARNY  
BLACK  
SCHWARZ

**LISTWA SCHODOWA Z WKŁADKĄ ANTYPOŚLIZGOWĄ**

**A38**



STAIRS SLAT WITH ANTI-SLIP INSERT  
STUFENLEISTE MIT ANTI-RUTSCH-EINSATZ (GUMMI)

DŁUGOŚĆ [m]  
Length | Länge

0,9	1,2*	1,8	2,7	3,6*
-----	------	-----	-----	------

**GUMA ANTYPOŚLIZGOWA DO LISTWY A38**

**A38G**



NON-SLIP RUBBER A38  
ANTI-RUTSCH-GUMMI A38

KOLORY GUMY A38G  
RUBBER COLOURS  
FARBEN

**88** CZARNY  
BLACK  
SCHWARZ

KĄTOWNIK 35 X 35

ANGLE BAR  
WINKELPROFIL

DŁUGOŚĆ [m]  
Length | Länge

0,9	1,2 *	1,8	2,7	3,6 *
-----	-------	-----	-----	-------

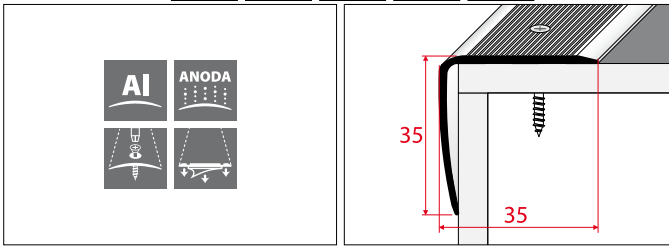

KĄTOWNIK 41 X 26,6

ANGLE BAR  
WINKELPROFIL

DŁUGOŚĆ [m]  
Length | Länge

0,9	1,2 *	1,8	2,7	3,6 *
-----	-------	-----	-----	-------

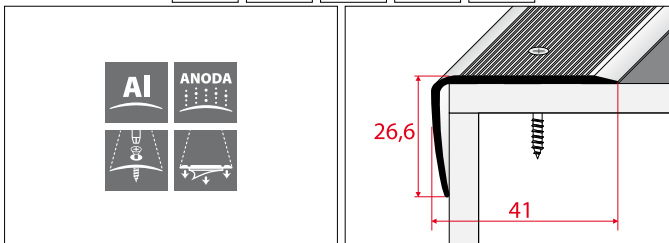

KĄTOWNIK Z TAŚMĄ ANTYPOŚLIZGOWĄ

ANGLE BAR WITH ANTI-SKIDDING TAPE  
WINKELPROFIL MIT ANTI-RUTSCH-EINSATZ (BAND)

DŁUGOŚĆ [m]  
Length | Länge

0,9	1,2 *	1,8	2,7	3,6 *
-----	-------	-----	-----	-------

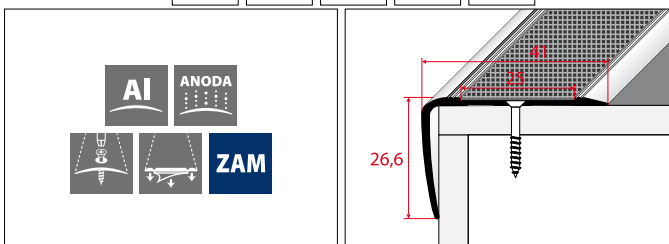

KĄTOWNIK 20 X 8

ANGLE BAR  
WINKELPROFIL

DŁUGOŚĆ [m]  
Length | Länge

0,9	1,8	2,7
-----	-----	-----

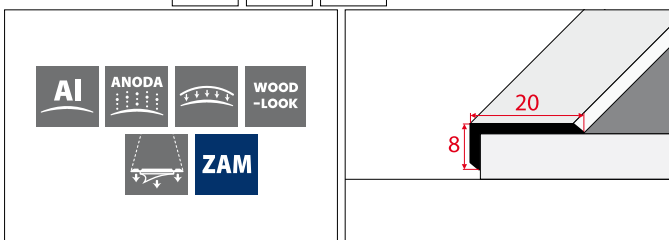



**LISTWA SCHODOWA**

**A60**



ANGLE BAR  
WINKELPROFIL

DŁUGOŚĆ [m] Length   Länge	0,9	1,2*	1,8	2,7	3,6*

**PROFIL ZAKOŃCZENIOWY**

**C23**



ENDING PROFILE  
ABSCHLUSSPROFIL

DŁUGOŚĆ [m] Length   Länge	0,9	1,2	1,8	2,7

**PROFIL ZAKOŃCZENIOWY**

**C24**



ENDING PROFILE  
ABSCHLUSSPROFIL

DŁUGOŚĆ [m] Length   Länge	0,9	1,2	1,8	2,7

**PROFIL ZAKOŃCZENIOWY**

**C25**



ENDING PROFILE  
ABSCHLUSSPROFIL

DŁUGOŚĆ [m] Length   Länge	0,9	1,2	1,8	2,7



PROFIL ZAKOŃCZENIOWY

ENDING PROFILE  
ABSCHLUSSPROFIL

DŁUGOŚĆ [m]  
Length | Länge

0,9

1,2

1,8

2,7

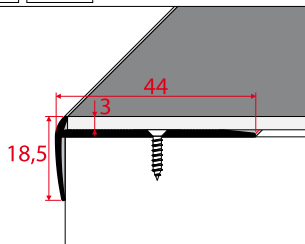
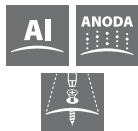

C26

PROFIL ZAKOŃCZENIOWY

ENDING PROFILE  
ABSCHLUSSPROFIL

DŁUGOŚĆ [m]  
Length | Länge

0,9

1,2

1,8

2,7

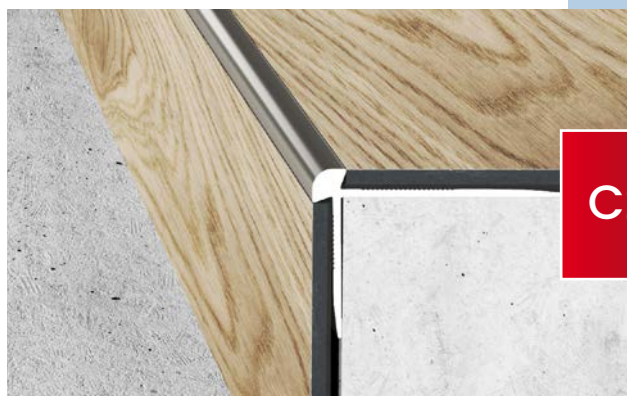
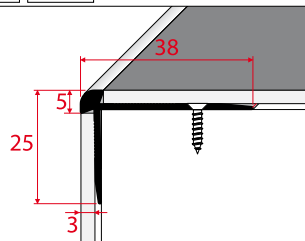
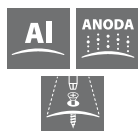

C28

PROFIL ZAKOŃCZENIOWY

ENDING PROFILE  
ABSCHLUSSPROFIL

DŁUGOŚĆ [m]  
Length | Länge

0,9

1,2

1,8

2,7

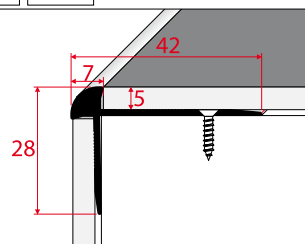
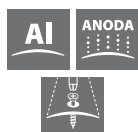

C29

KĄTOWNIK 25 X 10 SAMOPRZYLEPNY

ANGLE BAR SELF-ADHESIVE  
WINKELPROFIL SELBSTKLEBEND

DŁUGOŚĆ [m]  
Length | Länge

1,0

2,0

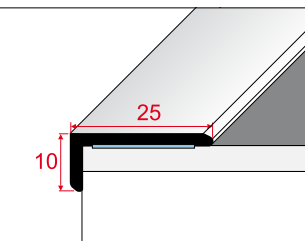

E31

KĄTOWNIK 35 X 20 SAMOPRZYLEPNY

E33



ANGLE BAR SELF-ADHESIVE  
WINKELPROFIL SELBSTKLEBEND

DŁUGOŚĆ [m]  
Length | Länge

1,0

2,0

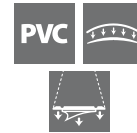
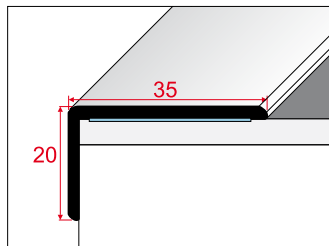







LISTWA MOCUJĄCA KRAWĘDZIE WYKŁADZIN

A01



FLOOR COVERING EDGE FIXING STRIP  
ABSCHLUSSLEISTE

DŁUGOŚĆ [m]  
Length | Länge

0,9

1,2 \*

1,8

2,7

3,6 \*

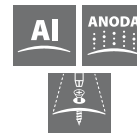
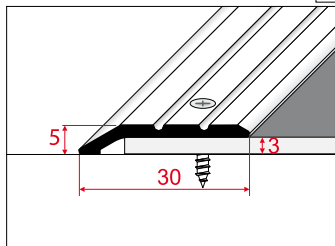

PRĘT SCHODOWY CHODNIKOWY Z UCHWYTEM MOCUJĄCYM

A06



STAIR FLOOR-CLOTH FASTENING BAR WITH MOUNTING HOLDER  
STUFENTEPPICHSTANGE MIT BEFESTIGUNG

DŁUGOŚĆ [m]  
Length | Länge

0,8

0,9

1,0

1,2 \*

1,35 \*

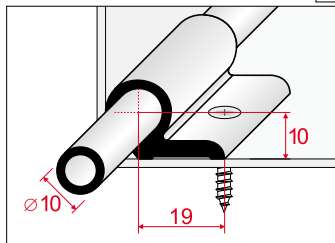

Pakowany po 3 szt.  
Packed by 3 pcs.  
Verpackungseinheit 3 Stck.

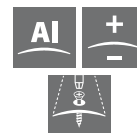

ZAKOŃCZENIE DO PRĘTÓW - KULKOWE

A06  
Z2



ENDS FOR BARS - BALL TYPE  
RUNDER ABSCHLUSS

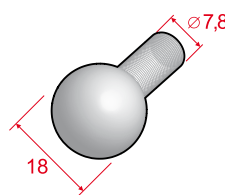

Pakowany po 2 szt.  
Packed by 2 pcs.  
Verpackungseinheit 2 Stck.



LISTWA MOCUJĄCA ZAKOŃCZENIOWA

A11



EDGING PROFILE  
ÜBERGANGSLEISTE SELBSTKLEBEND

DŁUGOŚĆ [m]  
Length | Länge

0,9

1,8

2,7

3,6 \*

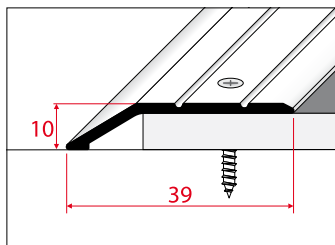

LISTWA ZAKOŃCZENIOWA

EDGING STRIP  
ABSCHLUSSLEISTE

DŁUGOŚĆ [m]  
Length | Länge

0,9	1,2*	1,8	2,7	3,6*
-----	------	-----	-----	------

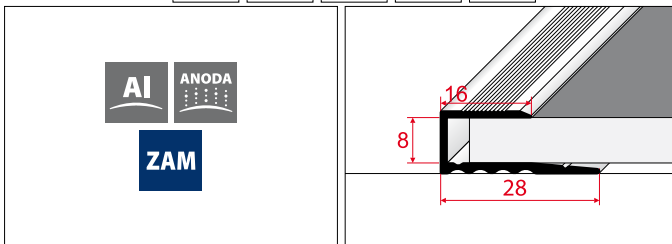

A63

PROFIL KRAWĘDZIOWY

EDGE PROFILE  
RANDPROFIL

DŁUGOŚĆ [m]  
Length | Länge

1,0	2,0	3,0
-----	-----	-----

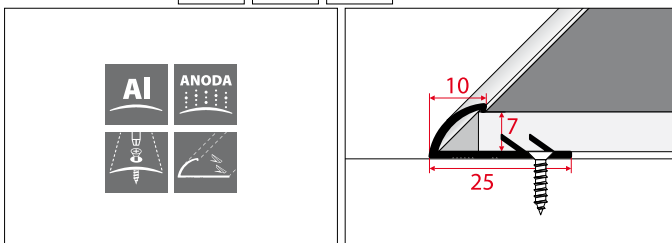

C07

PROFIL ZAKOŃCZENIOWY

ENDING PROFILE  
ABSCHLUSSPROFIL

DŁUGOŚĆ [m]  
Length | Länge

1,0	2,0	3,0
-----	-----	-----

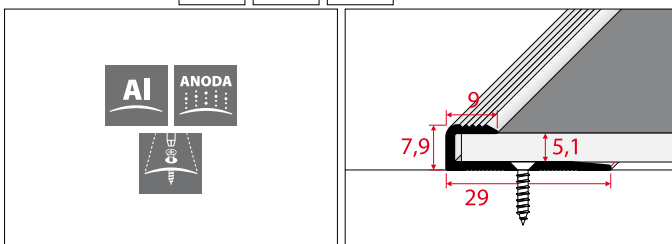

C63



# Listwy przypodłogowe



**Skirting boards**



# MULTI



# KOLORYSTYKA Q63

COLOURING | FARBE

## ALUMINIUM ANODOWANE

ANODISED ALUMINIUM | ALUMINIUM ELOXIERT



### LISTWA COKŁOWA ALUMINIOWA SAMOPRZYLEPNA

SKIRTING BOARD SELF-ADHESIVE  
SOCKELPROFIL SELBSTKLEBEND

DŁUGOŚĆ [m]  
Length | Länge

2,7

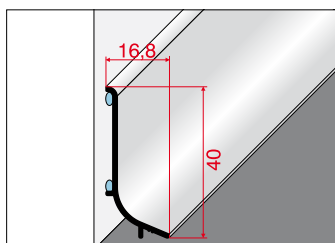

Q63

## NAROŻNIK WEWNĘTRZNY Q63

Q63 - INTERNAL CORNER  
Q63 - INNENECKEPakowany po 2 szt.  
Packed by 2 pcs.  
Verpackungseinheit 2 Stck.

PVC

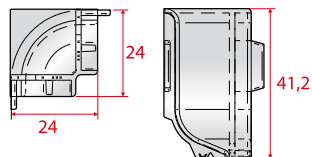

Multi

## NAROŻNIK ZEWNĘTRZNY Q63

Q63 - EXTERNAL CORNER  
Q63 - AUSSENECKEPakowany po 2 szt.  
Packed by 2 pcs.  
Verpackungseinheit 2 Stck.

PVC

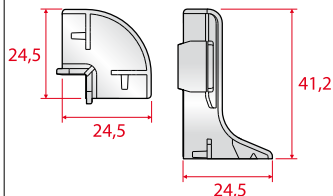

Multi

## ŁĄCZNIK Q63

CONNECTOR  
ZWISCHENSTUECKPakowany po 2 szt.  
Packed by 2 pcs.  
Verpackungseinheit 2 Stck.

PVC

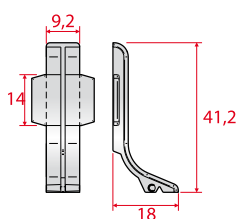

Multi

## ZAKOŃCZENIE PRAWE I LEWE Q63

RIGHT AND LEFT ENDING  
ENDSTÜCK LINKS UND RECHTSPakowane po 2 szt.  
(kpl. zakończenie prawe i lewe)  
Packed by 2 pcs.  
(right and left ending profile)  
Verpackt je 2 Stck.  
(Endstück links oder rechts)

PVC

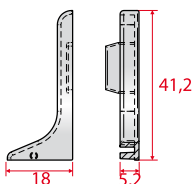

Multi



# KOLORYSTYKA EFFECTA

COLOURING | FARBE



EF001



EF002



EF003



EF004



EF005



EF006



EF007



EF008



EF009



EF010



EF011



EF012



EF013



EF014

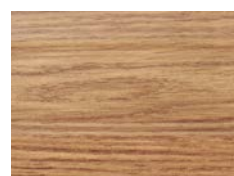

EF015



EF016



EF017



EF018

## LISTWA PRZYPODŁOGOWA PVC

Effecta



PVC SKIRTING BOARD  
SOCKELLEISTE

DŁUGOŚĆ [m]  
Length | Länge

2,5

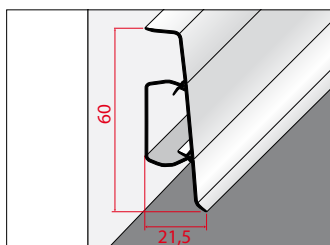

Pakowany po 27 szt.  
Packed by 27 pcs.  
Verpackungseinheit 27 Stck.



## NAROŻNIK WEWNĘTRZNY

INTERNAL CORNER  
INNENECKE

Pakowany po 25 szt.  
Packed by 25 pcs.  
Verpackungseinheit 25 Stck.

PVC

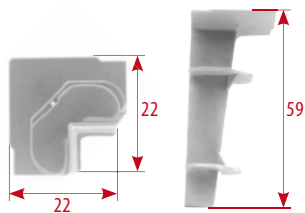

Effecta

## NAROŻNIK ZEWNĘTRZNY

EXTERNAL CORNER  
AUSSENECKE

Pakowany po 25 szt.  
Packed by 25 pcs.  
Verpackungseinheit 25 Stck.

PVC

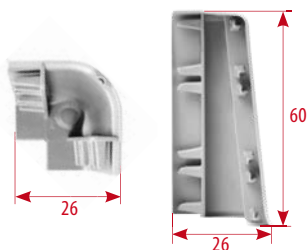

Effecta

## ŁĄCZNIK

CONNECTOR  
ZWISCHENSTUECK

Pakowany po 25 szt.  
Packed by 25 pcs.  
Verpackungseinheit 25 Stck.

PVC

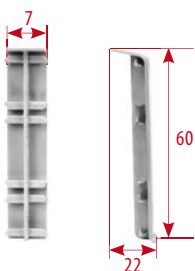

Effecta

## ZAKOŃCZENIE PRAWE I LEWE

RIGHT AND LEFT ENDING  
ENDSTÜCK LINKS UND RECHTS

Pakowane po 25 szt.  
(kpl. zakończenie prawe i lewe)  
Packed by 25 pcs.  
(right and left ending profile)  
Verpackt je 25 Stck. oder Sätze  
(Endstück links oder rechts)

PVC

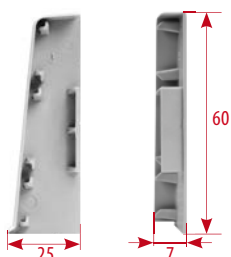

Effecta

# KOLORYSTYKA CLASSIC

COLOURING | FARBE



CL001



CL002



CL003



CL004



CL005



CL006

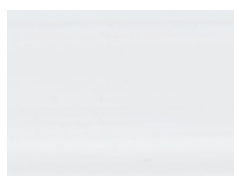

CL007



CL008



CL009



CL010



CL011



CL012



CL013



CL014



CL015



CL016



CL017



CL018



CL019

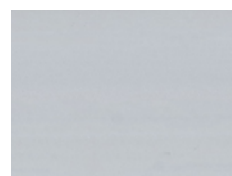

CL020

## LISTWA PRZYPODŁOGOWA PVC

Classic



PVC SKIRTING BOARD  
SOCKELLEISTE

DŁUGOŚĆ [m]  
Length | Länge

2,5

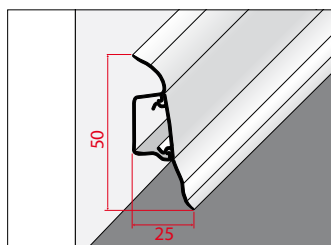

Pakowany po 40 szt.  
Packed by 40 pcs.  
Verpackungseinheit 40 Stck.





## NAROŻNIK WEWNĘTRZNY

INTERNAL CORNER  
INNENECKEPakowany po 25 szt.  
Packed by 25 pcs.  
Verpackungseinheit 25 Stck.

PVC

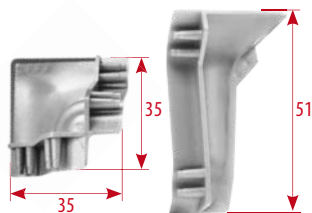

Classic

## NAROŻNIK ZEWNĘTRZNY

EXTERNAL CORNER  
AUSSENECKEPakowany po 25 szt.  
Packed by 25 pcs.  
Verpackungseinheit 25 Stck.

PVC

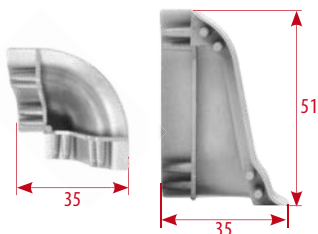

Classic

## ŁĄCZNIK

CONNECTOR  
ZWISCHENSTUECKPakowany po 25 szt.  
Packed by 25 pcs.  
Verpackungseinheit 25 Stck.

PVC

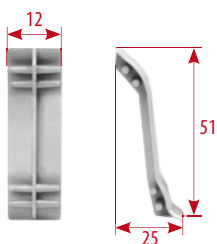

Classic

## ZAKOŃCZENIE PRAWE I LEWE

RIGHT AND LEFT ENDING  
ENDSTÜCK LINKS UND RECHTSPakowane po 25 szt.  
(kpl. zakończenie prawe i lewe)  
Packed by 25 pcs.  
(right and left ending profile)  
Verpackt je 25 Stck. oder Sätze  
(Endstück links oder rechts)

PVC

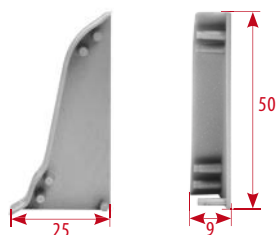

Classic

# Profile do glazury i terakoty



# IMPRESJA

Profiles for tiles





# ALUMINIUM ANODOWANE

ANODISED ALUMINIUM | ALUMINIUM ELOXIERT



01

**SREBRO**  
SILVER  
SILBER

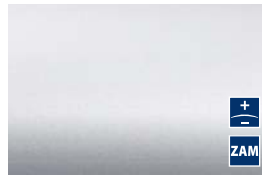

E01

**SREBRO  
- ELEKTROPOLER**  
SILVER ELECTROPOLISHED  
SILBER MIT ELEKTROPOLIERT



71

**INOX GŁADKI**  
INOX SMOOTH  
INOX GLATT



07

**INOX  
SZCZOTKOWANY**  
BRUSHED INOX  
GEBÜRSTET INOX



00

**ZŁOTO**  
GOLD  
GOLD



02

**SZAMPAN**  
CHAMPAGNE  
CHAMPAGNE



005

**CZARNY**  
BLACK  
SCHWARZ

# ALUMINIUM NATURALNE

NATURAL ALUMINIUM | NATUR ALUMINIUM

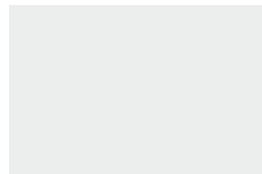

90

**NATURALNE**  
NATURAL  
NATUR



91

**POLEROWANE**  
POLISHED  
POLIERT, GLÄNZEND

# PROFILE PAKOWANE PO 5 SZT.

PROFILES PACKED BY 5 PIECES. | PROFILE VERPACKT ZU JE 5 STK



PROFIL KRAWĘDZIOWY

EDGE STRIP  
RANDLEISTE

DŁUGOŚĆ [m]  
Length | Länge

1,0	2,0	2,5	3,0
-----	-----	-----	-----

	A
A50	8
A51	10
A52	12

AI  
ANODA  
+  
-

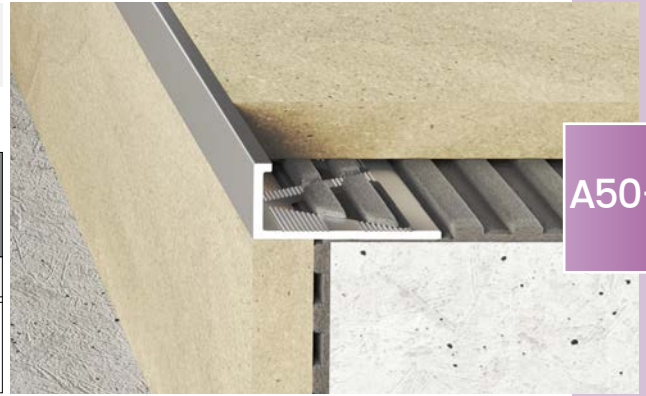

A50-52

PROFIL KRAWĘDZIOWY OWALNY

OVAL EDGE STRIP  
RANDLEISTE, OVAL

DŁUGOŚĆ [m]  
Length | Länge

1,0	2,0	2,5	3,0
-----	-----	-----	-----

	A
A53	8
	10
	12

AI  
ANODA  
+  
-



A53

PROFIL FUGOWY

JOINT PROFIL  
FUGENPROFIL

DŁUGOŚĆ [m]  
Length | Länge

1,0	2,0	2,5	3,0
-----	-----	-----	-----

	A
A54	13
A55	18
A56	26

AI  
ANODA  
+  
-



A54-56

PROFIL ŁĄCZENIOWY PŁASKI

FLAT JOINING STRIP  
ÜBERGANGSLEISTE, FLACH

DŁUGOŚĆ [m]  
Length | Länge

1,0	2,0	2,5	3,0
-----	-----	-----	-----

AI ANODA



A57

PROFIL SCHODOWY

A58



STAIR STRIP  
STUFENLEISTE

DŁUGOŚĆ [m]  
Length | Länge

1,0

2,0

2,5

3,0

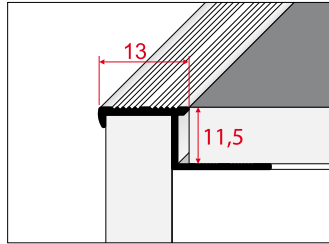

PROFIL NAJAZDOWY

A59



APPROACHING STRIP  
AUSGLEICHLEISTE

DŁUGOŚĆ [m]  
Length | Länge

1,0

2,0

2,5

3,0

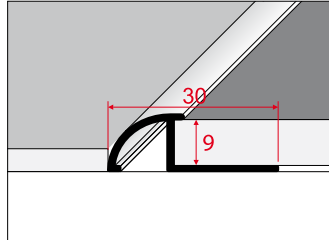

PROFIL SCHODOWY PÓŁOKRĄGLY

A80



HALF-ROUNDED STAIR STRIP  
STUFENPROFIL

DŁUGOŚĆ [m]  
Length | Länge

1,0

2,0

2,5

3,0

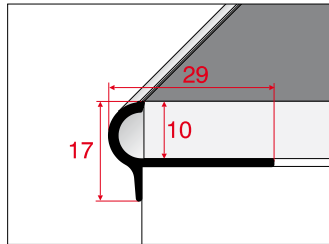

PROFIL SCHODOWY OWALNY

A81



OVAL STAIR STRIP  
STUFENPROFIL

DŁUGOŚĆ [m]  
Length | Länge

1,0

2,0

2,5

3,0

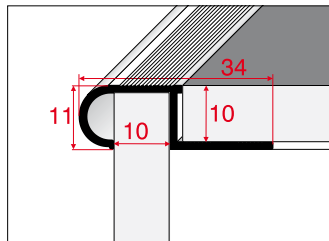



PROFIL DEKORACYJNY RIO

DECORATIVE STRIP RIO  
ZIERLEISTE RIO

DŁUGOŚĆ [m]  
Length | Länge **2,7**

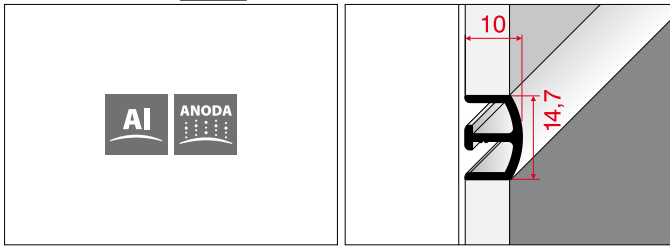

A82

PROFIL DO GLAZURY Z ZAKOŃCZENIAMI ZEWNĘTRZNYMI I WEWNĘTRZNYMI

TILE PROFILE WITH EXTERNAL AND INTERNAL CORNER ELEMENTS  
FLIESENPROFIL MIT INNEN- UND AUSSENECKEN

DŁUGOŚĆ [m]  
Length | Länge **2,5**

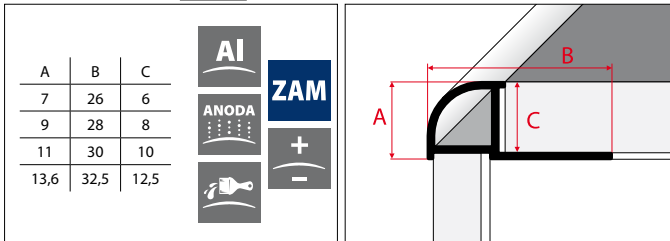

A83

ZAKOŃCZENIA ZEWNĘTRZNE I WEWNĘTRZNE DO PROFILU A83

EXTERNAL AND INTERNAL CORNER ELEMENTS  
INNEN UND AUSSEN ABSCHLUSS PASSEND ZUR LEISTE A83

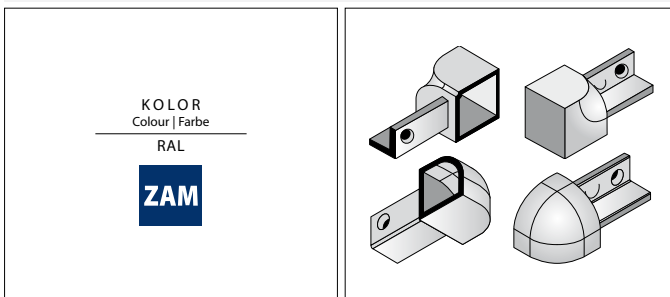

A83

PROFIL DEKORACYJNY RIO

DECORATIVE STRIP RIO  
ZIERLEISTE RIO

DŁUGOŚĆ [m]  
Length | Länge **2,7**

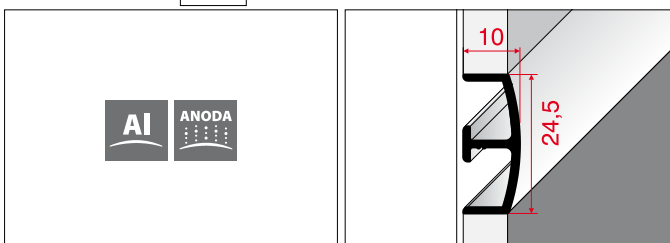

A84

PROFIL SCHODOWY DO GLAZURY

A85



STAIR PROFILE FOR TILES  
STUFENPROFIL ZU DER KERAMIKFLIESEN

DŁUGOŚĆ [m]  
Length | Länge

1,0

2,0

2,5

3,0

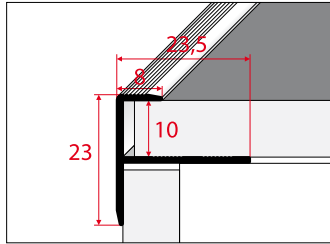

PROFIL ZAKOŃCZENIOWY

A86



ENDING PROFILE  
ABSCHLUSSLEISTE

DŁUGOŚĆ [m]  
Length | Länge

2,5

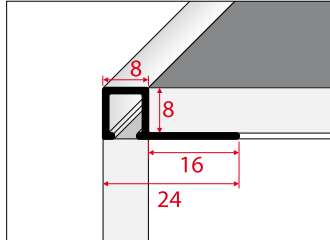

PROFIL ZAKOŃCZENIOWY

A87



ENDING PROFILE  
ABSCHLUSSLEISTE

DŁUGOŚĆ [m]  
Length | Länge

2,5

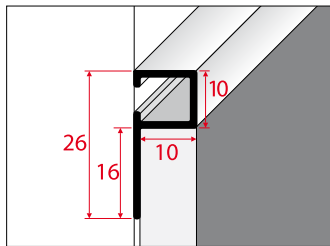

PROFIL ZAKOŃCZENIOWY

A88



ENDING PROFILE  
ABSCHLUSSLEISTE

DŁUGOŚĆ [m]  
Length | Länge

2,5

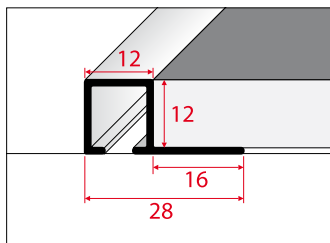

PROFIL WEWNĘTRZNY

INNER STRIP  
INNENLEISTE

DŁUGOŚĆ [m]  
Length | Länge

1,0

2,0

2,5

3,0

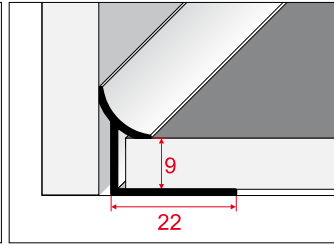

A96

PROFIL NAROŻNY SCHODOWY Z GUMĄ

STAIR PROFILE WITH ANTI-SLIP LINING RUBBER  
ECKLEISTE FÜR TREPPEN MIT GUMMIBAND

DŁUGOŚĆ [m]  
Length | Länge

2,5

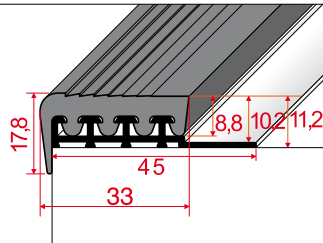

A97  
+A98

KOLORY GUMY A98  
RUBBER COLOURS  
FARBEN



88

CZARNY  
BLACK  
SCHWARZ



86

BRAZ  
BROWN  
BRAUN



89

SZARY  
GREY  
GRAU

PROFIL OKAPOWY

HOOD PROFILE  
WETTERSCHENKEL

DŁUGOŚĆ [m]  
Length | Länge

2,5

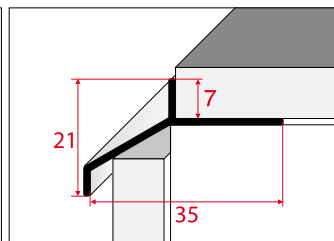

A99



# KOLORY P53, P96

COLOURS | FARBEN



## PROFIL ZAKOŃCZENIOWY ZEWNĘTRZNY

P53



EDGE STRIP  
RANDLEISTE

DŁUGOŚĆ [m]  
Length | Länge **2,5**

Pakowane po 25 szt.  
Packed by 25 pcs.  
Verpackungseinheit 25 Stck.

A
7
8
9
10

**P53**

**PVC**

## PROFIL ZAKOŃCZENIOWY WEWNĘTRZNY

P96



INNER STRIP  
INNENLEISTE

DŁUGOŚĆ [m]  
Length | Länge **2,5**

Pakowane po 25 szt.  
Packed by 25 pcs.  
Verpackungseinheit 25 Stck.

A
7
8
9
10

**P96**

**PVC**

PROFIL WANNOWY SAMOPRZYLEPNY Z AKCESORIAMI

BATH STRIP SELF-ADHESIVE WITH ACCESSORIES  
DAS PROFIL ZUR BADENWANNE MIT ZUBEHÖREN SELBSTKLEBEND

DŁUGOŚĆ [m]  
Length | Länge **1,83**

KOLOR  
Colour | Farbe 8000

Akcesoria: 2 x Narożnik wewnętrzny, zakończenie prawe i lewe  
Accessories: 2 x internal corner profile, right and left ending  
Zubehör: 2 x Innenecke, 2 x Endstuecke

Pakowana po 22 szt.  
Packed by 22 pcs.  
Verpackungseinheit 22 Stck.

**PVC**

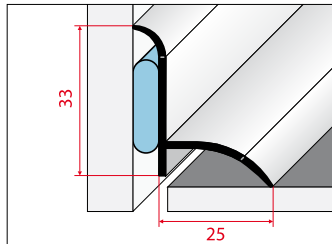

P56

KOLORYSTYKA P61  
P61 - COLOURING | P61 - FARBE

<b>701</b> BIAŁY WHITE WEISS	<b>702</b> BIAŁY MARM. WHITE MARBLED WEISS MARMOR	<b>703</b> BUK JASNY LIGHT BEECH BUCHE HELL	<b>704</b> DĄB JASNY LIGHT OAK EICHE HELL	<b>705</b> BEŻOWY BEIGE BEIGE
<b>707</b> ORZECH NUT NUSS	<b>709</b> WENGE WENGE WENGE	<b>801</b> SREBRNY BŁYSK SHINING SILVER SILBER BLITZ	<b>802</b> SREBRNY MAT MATT SILVER SILBER MATT	<b>8800</b> CZARNY BLACK SCHWARZ

LISTWA PRZYBLATOWA

SKIRTING BOARD  
LEISTEN FÜR ARBEITSPLATTEN

DŁUGOŚĆ [m]  
Length | Länge **3,0**

Pakowana po 20 szt.  
Packed by 20 pcs.  
Verpackungseinheit 20 Stck.

**PVC**

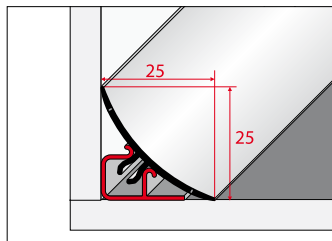

P61

ZAKOŃCZENIE PRAWIE LUB LEWE

RIGTH OR LEFT ENDING PROFILE  
ENDSTÜCK LINKS ODER RECHTS



Pakowane po 30 szt.  
Packed by 30 pcs.  
Verpackungseinheit 30 Stck.

**PVC**

NAROŻNIK WEWNĘTRZNY

INTERNAL CORNER PROFILE  
INNENECKE



Pakowane po 30 szt.  
Packed by 30 pcs.  
Verpackungseinheit 30 Stck.

**PVC**



Profile  
wykończeniowe gięte



# Bendable finishing \_ profiles

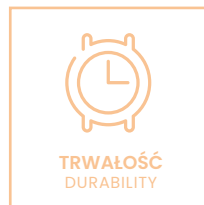

# ALUMINIUM ANODOWANE

ANODISED ALUMINIUM | ALUMINIUM ELOXIERT



**01** SREBRO  
SILVER  
SILBER



**71** INOX GŁADKI  
INOX SMOOTH  
INOX GLATT



**00** ZŁOTO  
GOLD  
GOLD



**02** SZAMPAN  
CHAMPAGNE  
CHAMPAGNE



**005** CZARNY  
BLACK  
SCHWARZ

# ALUMINIUM NATURALNE

NATURAL ALUMINIUM | NATUR ALUMINIUM

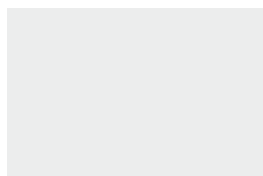

**90** NATURALNE  
NATURAL  
NATUR

# ALUMINIUM OKLEINOWANE

VENEERED ALUMINIUM | ALUMINIUM UMMANTELT



**28** BUK JASNY  
LIGHT BEECH  
BUCHE HELL



**08** BUK  
BEECH  
BUCHE



**20916** DĄB BIAŁY  
RAW OAK  
EICHE WEIB



**20901** DĄB BIELONY  
WHITE OAK  
EICHE GEBLEICHT



**20918** DĄB BERGERAC  
BERGERAC OAK  
EICHE BERGERAC



**20917** DĄB JAŚMINOWY  
JASMINE OAK  
EICHE JASMIN



**20915** DĄB WANILIA  
VANILLA OAK  
EICHE VANILLE

# ALUMINIUM OKLEINOWANE

VENEERED ALUMINIUM | ALUMINIUM UMMANTELT



**20913** **DĄB MALAGA**  
MALAGA OAK  
EICHE MALAGA



**20919** **DĄB SZARY**  
GRAY OAK  
EICHE GRAUE



**20902** **DĄB MOCCA**  
MOCCA OAK  
EICHE MOCCA



**20912** **DĄB TABACCO**  
TABACCO OAK  
EICHE TABACCO



**20904** **DĄB ARCTIC**  
ARCTIC OAK  
EICHE ARCTIC



**20920** **DĄB NATURALNY**  
NATURAL OAK  
EICHE NATUR



**20921** **DĄB LEMON**  
LEMON OAK  
EICHE LEMON



**20908** **DĄB PIWNY**  
BERRY OAK  
EICHE HELLBRAUN



**29** **DĄB JASNY**  
LIGHT OAK  
EICHE HELL



**20907** **DĄB PIĄSKOWY**  
SANDY OAK  
EICHE SAND

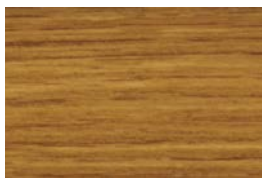

**20906** **DĄB KONIAKOWY**  
COGNAC OAK  
EICHE COGNAC



**20905** **DĄB BURSZTYNOWY**  
AMBER OAK  
EICHE BERNSTEIN



**20903** **DĄB ANTYCZNY**  
ANTIQUE OAK  
EICHE ANTIK



**20914** **DĄB TOPAZ**  
TOPAZ OAK  
EICHE TOPAS



**20911** **DĄB VERDEN**  
VERDEN OAK  
EICHE VERDEN

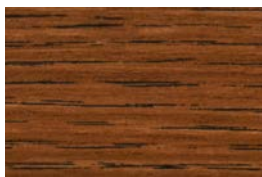

**20910** **DĄB ZAMKOWY**  
CASTLE OAK  
SCHLOSS EICHE

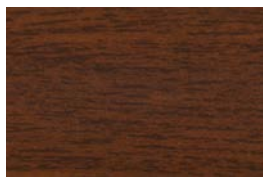

**0909** **DĄB ZŁOCISTY**  
GOLDEN OAK  
EICHE GOLD



**09** **DĄB**  
OAK  
EICHE

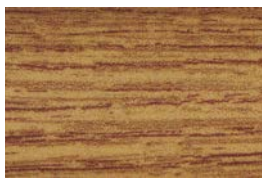

**34** **WIAZ**  
ELM  
ULME

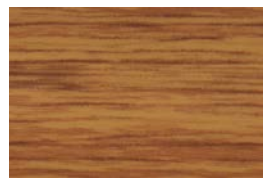

**32** **HIKORA**  
HICKORY  
HIKORYBAUM



**20922** **ORZECH SIENNA**  
SIENNA NUT  
SIENNE NUSS



**2701** **ORZECH CHILE**  
CHILE NUT  
NUSSBAUM CHILE



**20944** **MERBAU**  
MERBAU  
MERBAU

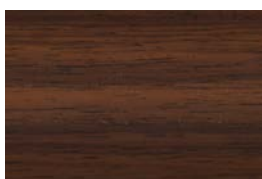

**4500** **TEAK INDYJSKI**  
INDIAN TEAK  
INDISCHER TEAK



**33** **AFREZJA**  
AFREZY  
AFREZY



**3101** **KASZTAN JAPONSKI**  
JAPANESE CHESTNUT  
JAPANISCHE KASTANIE

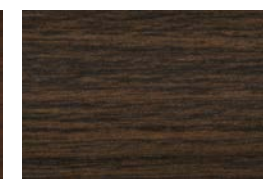

**4201** **WENGE KONGO**  
CONGO WENGE  
WENGE KONGO



PROFIL NAROŻNY GIĘTY

S53



BENDABLE CORNER PROFILE  
ECKPROFIL GEBOGEN

DŁUGOŚĆ [m]  
Length | Länge **2,5**

PROFIL ŁĄCZENIOWY GIĘTY

S57



BENDABLE JOINING PROFILE  
VERBINDUNGSPROFIL BIEGSAM

DŁUGOŚĆ [m]  
Length | Länge **2,5**

PROFIL ŁĄCZENIOWY GIĘTY

S92



BENDABLE JOINING PROFILE  
VERBINDUNGSPROFIL BIEGSAM

DŁUGOŚĆ [m]  
Length | Länge **2,5**

PROFIL ZAKOŃCZENIOWY GIĘTY

S93



BENDABLE FINISHING PROFILE  
ABSCHLUSSPROFIL BIEGSAM

DŁUGOŚĆ [m]  
Length | Länge **2,5**

PROFIL NAROŻNY GIĘTY

BENDABLE CORNER PROFILE  
ECKPROFIL GEBOGEN

DŁUGOŚĆ [m]  
Length | Länge **3,0**

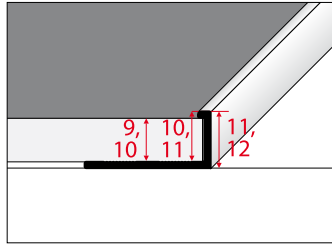

**S94**





# Kształtowniki dla **majsterkowiczów**

DIY profiles



# EASY

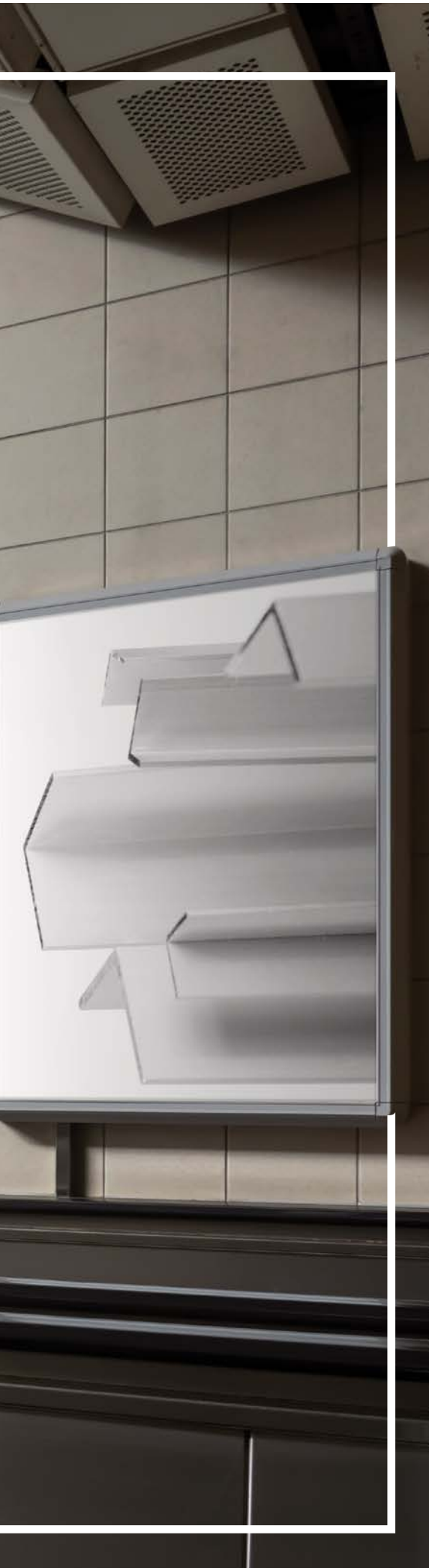

**BEZPIECZEŃSTWO**  
SAFETY



**TRWAŁOŚĆ**  
DURABILITY



**ELEGANCJA**  
ELEGANCE



**PRODUKT POLSKI**  
POLISH PRODUCT



**NOWOCZESNY  
DESIGN**  
MODERN DESIGN



**EKSPRESOWY  
MONTAŻ**  
QUICK MOUNT



**ODPORNOŚĆ  
NA ZARYSOWANIA**  
SCRATCH RESISTANT



**PRZYJAZNE  
ŚRODOWISKU**  
ECO-FRIENDLY



**BEZ ZAWARTOŚCI  
OŁOWIU**  
LEAD FREE

# ALUMINIUM ANODOWANE

ANODISED ALUMINIUM | ALUMINIUM ELOXIERT



01

**SREBRO**  
SILVER  
SILBER



71

**INOX GŁADKI**  
INOX SMOOTH  
INOX GLATT



07

**INOX SZCZOTKOWANY**  
BRUSHED INOX  
GEBÜRSTET INOX



00

**ZŁOTO**  
GOLD  
GOLD



005

**CZARNY**  
BLACK  
SCHWARZ

# ALUMINIUM NATURALNE

NATURAL ALUMINIUM | NATUR ALUMINIUM

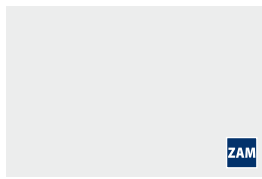

90

**NATURALNE**  
NATURAL  
NATUR

# ALUMINIUM LAKIEROWANE

LACQUERED ALUMINIUM | LACKIERTES ALUMINIUM



9016

**BIAŁY**  
WHITE  
WEISS

# PROFILE PAKOWANE PO 5 SZT.

PROFILES PACKED BY 5 PIECES. | PROFILE VERPACKT ZU JE 5 STK

## PŁASKOWNIK

B00-05



FLAT SHAPE SECTION  
FLACHLEISTE

DŁUGOŚĆ [m]  
Length | Länge

1,0

2,0

3,0\*

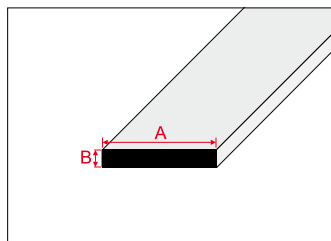

	A	B
<b>B00</b>	15	3
<b>B01</b>	20	3
<b>B02</b>	25	2
<b>B03</b>	25	3
<b>B04</b>	40	3
<b>B05</b>	50	2



\*

KĄTOWNIK RÓWNORAMIENNY

EQUAL-SIDED ANGLE BAR  
WINKELPROFIL, GLEICHSCHENKLIG

DŁUGOŚĆ [m]  
Length | Länge

1,0

2,0

3,0\*

	A	B	C
<b>B10</b>	20	20	2
<b>B11</b>	25	25	2
<b>B12</b>	15	15	1,5
<b>B13</b>	12	12	2
<b>B14</b>	30	30	2
<b>B15</b>	35	35	3
<b>B16</b>	40	40	2
<b>B17</b>	50	50	3

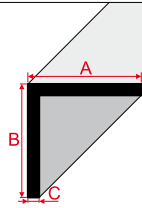

B10-17

KĄTOWNIK NIERÓWNORAMIENNY

NON-EQUAL SIDED ANGLE BAR  
WINKELPROFIL, NICHT GLEICHSCHENKLIG

DŁUGOŚĆ [m]  
Length | Länge

1,0

2,0

3,0\*

	A	B	C
<b>B20</b>	40	20	2
<b>B21</b>	30	20	2
<b>B22</b>	25	20	2
<b>B23</b>	20	10	2

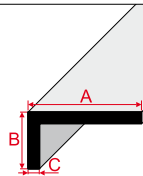

B20-23

KĄTOWNIK FAZOWANY

CHAMFERED ANGLE BAR  
WINKELPROFIL, GEFAST

DŁUGOŚĆ [m]  
Length | Länge

1,0

2,0

3,0\*

	A	B	C
<b>B24</b>	20	8	1,5
<b>B25</b>	14	10	1,5

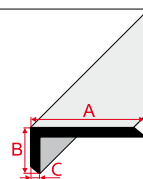

B24-25

CEOWNIK

CHANNEL BAR  
U-PROFIL

DŁUGOŚĆ [m]  
Length | Länge

1,0

2,0

3,0\*

	A	B	C
<b>B30</b>	10	10	1,5

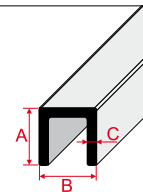

B30



## CEOWNIK NIERÓWNORAMIENNY

B31



NON-EQUAL SIDED CHANNEL BAR  
U-PROFIL, NICHT GLEICHSCHENKLIG

DŁUGOŚĆ [m]  
Length | Länge

1,0

2,0

3,0\*

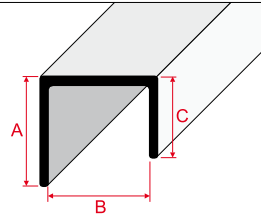

	A	B	C
<b>B31</b>	19,3	18	14,3



## RURA

B40-45



TUBE  
RUNDROHR

DŁUGOŚĆ [m]  
Length | Länge

1,0

2,0

3,0\*

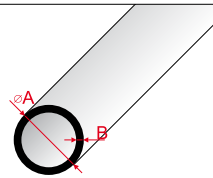

	A	B
<b>B40</b>	5	1
<b>B41</b>	8	1
<b>B42</b>	10	1
<b>B43</b>	12	1
<b>B45</b>	20	1,5



## RURA PROSTOKĄTNA

B50-52



RECTANGULAR TUBE  
ROHR, RECHTECKIG

DŁUGOŚĆ [m]  
Length | Länge

1,0

2,0

3,0\*

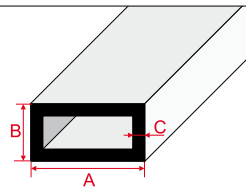

	A	B	C
<b>B50</b>	12	10	1
<b>B51</b>	15	10	1,2
<b>B52</b>	20	10	2



## RURA KWADRATOWA

B53-55



SQUARE TUBE  
4KT ROHR

DŁUGOŚĆ [m]  
Length | Länge

1,0

2,0

3,0\*

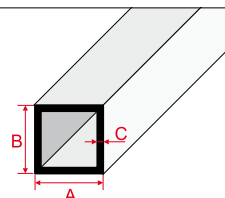

	A	B	C
<b>B53</b>	12	12	1
<b>B54</b>	15	15	1
<b>B55</b>	20	20	1



CEOWNIK RYFLOWANY

RIFFLED CHANNEL BAR  
U-PROFIL, GERIFFELT

DŁUGOŚĆ [m]  
Length | Länge

1,0

2,0

3,0\*

	A	B	C	D
<b>B60</b>	10	10,9	8,5	7,5
<b>B61</b>	10	12,9	10,5	9,5
<b>B62</b>	10	16,1	13,5	12,5
<b>B63</b>	21	21,1	18,5	17,5

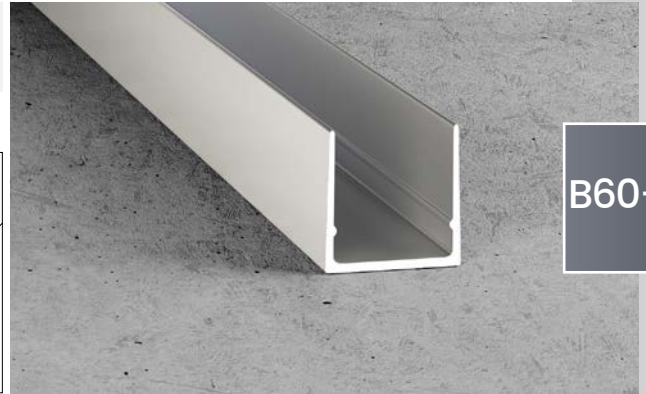
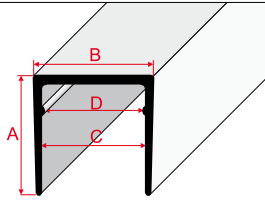

B60-63

CEOWNIK

CHANNEL BAR  
U-PROFIL

DŁUGOŚĆ [m]  
Length | Länge

1,0

2,0

3,0\*

	A	B	C
<b>B81</b>	20	18	20,6

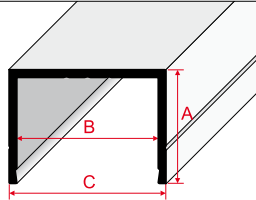

B81

TEOWNIK

T-BAR  
T-PROFIL

DŁUGOŚĆ [m]  
Length | Länge

1,0

2,0

3,0\*

	A	B	C
<b>B90</b>	20	20	2

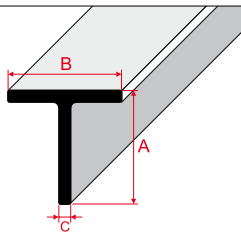

B90

HAOWNIK

H-BAR  
H-PROFIL

DŁUGOŚĆ [m]  
Length | Länge

1,0

2,0

3,0\*

	A	B	C
<b>B91</b>	40	12	8

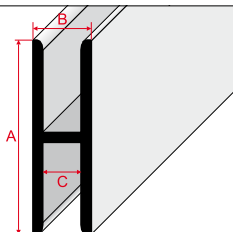

B91

# ALUMINIUM ANODOWANE

ANODISED ALUMINIUM | ALUMINIUM ELOXIERT



**01** SREBRO  
SILVER  
SILBER



**00** ZŁOTO  
GOLD  
GOLD



**02** SZAMPAN  
CHAMPAGNE  
CHAMPAGNE



**03** BRAŹ  
BROWN  
BRAUN

# ALUMINIUM LAKIEROWANE

LACQUERED ALUMINIUM | LACKIERTES ALUMINIUM



**9016** BIAŁY  
WHITE  
WEISS



**081** BEŻ  
BEIGE  
BEIGE



**080** BUKOWY  
BEECH  
BUCHENHOLZ



**082** BRAŹ  
BROWN  
BRAUN





PROFIL ZAKOŃCZENIOWY PRAWY

RIGHT ENDING PROFILE  
ABSCHLUSSLEISTE, RECHTS

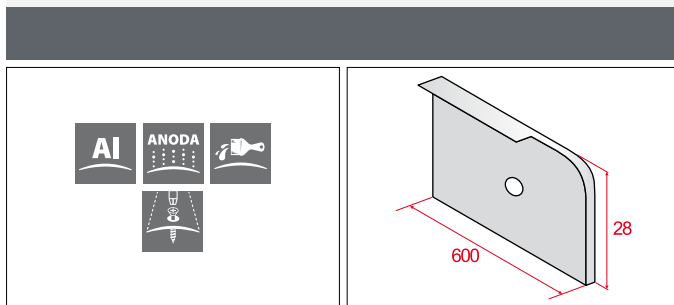

PROFIL ZAKOŃCZENIOWY LEWY

LEFT ENDING PROFILE  
ABSCHLUSSLEISTE, LINKS

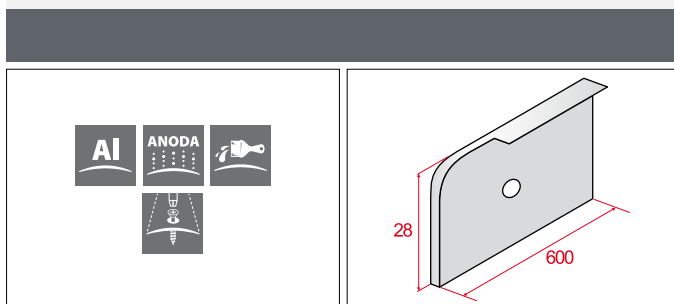

PROFIL ŁĄCZENIOWY GIĘTY

BOWLED JOINING PROFILE  
VERBINDUNGSLEISTE, ELASTISCH

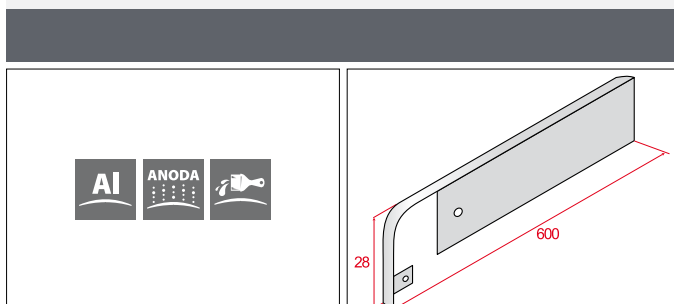

PROFIL ŁĄCZENIOWY

JOINING PROFILE  
VERBINDUNGSLEISTE

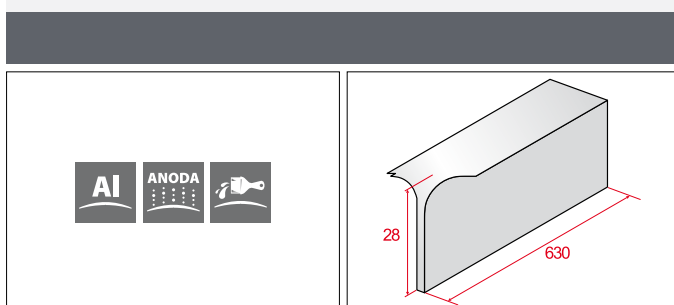



Profile  
budowlane PVC

# Building PVC profiles

# FANTAZJA



**BEZPIECZEŃSTWO**  
SAFETY



**TRWAŁOŚĆ**  
DURABILITY



**ELEGANCJA**  
ELEGANCE



**BOGATA GAMA  
KOLORYSTYCZNA**  
COLORFUL



**NOWOCZESNY  
DESIGN**  
MODERN DESIGN



**PRODUKT POLSKI**  
POLISH PRODUCT



**EKSPRESOWY  
MONTAŻ**  
QUICK MOUNT



**WYJĄTKOWA  
ELASTYCZNOŚĆ**  
UNIQUE ELASTIC



**PRZYJAZNE  
ŚRODOWISKU**  
ECO-FRIENDLY



**BEZ ZAWARTOŚCI  
OŁOWIU**  
LEAD FREE



# KOLORY

COLOURS | FARBEN



**8000** BIAŁY  
WHITE  
WEISS



**2800** BUK JASNY  
LIGHT BEECH  
BUCHE HELL



**0800** BUK  
BEECH  
BUCHE



**3000** SOSNA  
PINE  
KIEFER



**2300** OLCHA  
ALDER  
ERLE



**2900** DĄB JASNY  
LIGHT OAK  
EICHE HELL



**0901** DĄB CIEMNY  
DARK OAK  
EICHE DUNKEL



**0240** MAHOŃ  
MAHOGANY  
MAHAGONI



**0270** ORZECH  
NUT  
NUSS



**0271** ORZECH  
GRECKI  
GREEK WALNUT  
NUSS GRIECHISCH



**4201** WENGE  
KONGO  
CONGO WENGE  
WENGE KONGO



**20902** DĄB MOCCA  
MOCCA OAK  
EICHE MOCCA



**20904** DĄB ARCTIC  
ARCTIC OAK  
EICHE ARCTIC

## PROFILE PAKOWANE PO 15 SZT.

PROFILES PACKED BY 15 PIECES. | PROFILE VERPACKT ZU JE 15 STK

### LISTWA BUDOWLANA

F01-04



BUILDING PROFILE  
BAULEISTE

DŁUGOŚĆ [m]  
Length | Länge

2,2

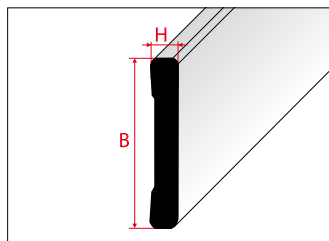

	B	H	KOLOR Colour   Farbe
<b>F01</b>	40	6	8000, 0240, 0270
<b>F02</b>	50	7	8000
<b>F03</b>	60	8	8000
<b>F04</b>	70	9	8000

PVC

LISTWA MASKUJĄCA

MASKING PROFILE  
MASKIERLEISTE

DŁUGOŚĆ [m]  
Length | Länge **2,7**

	B	KOLOR Colour   Farbe
<b>F05</b>	30	8000
<b>F06</b>	19	8000

**PVC**

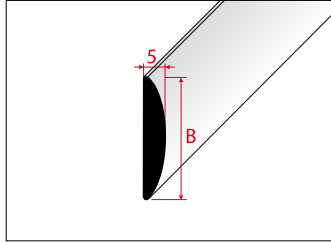

F05-06

ĆWIERĆWAŁEK „13 X 8”

QUADRANT MOULDING  
VIERTELSTAB

DŁUGOŚĆ [m]  
Length | Länge **2,7**

KOLOR Colour   Farbe	8000
<b>PVC</b>	

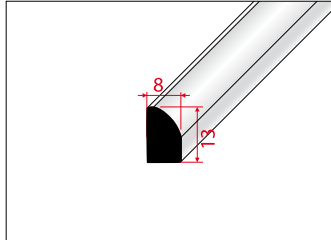

F07

ĆWIERĆWAŁEK „10”; „14”

QUADRANT MOULDING  
VIERTELSTAB

DŁUGOŚĆ [m]  
Length | Länge **2,7**

	H	KOLOR Colour   Farbe
<b>F08</b>	10	8000, 2900, 20904, 20902, 0271
<b>F09</b>	14	8000, 2900, 0240, 0270, 0271, 20902

**PVC**

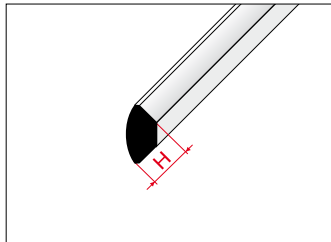

F08-09

NAROŻNIK BUDOWLANY „20”; „30”

CORNER PROFILE  
ECKLEISTE

DŁUGOŚĆ [m]  
Length | Länge **2,7**

KOLOR Colour   Farbe	8000
<b>PVC</b>	
	B
<b>F10</b>	20

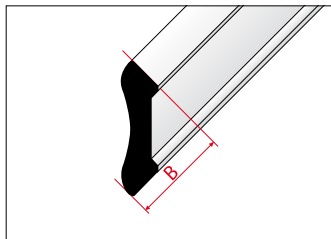

F10

KĄTOWNIK

F14-16  
F19-22



ANGLE BAR  
L PROFIL

DŁUGOŚĆ [m] **2,75**  
Length | Länge

KOLORY JEDNOLITE  
PLAIN COLOURS  
STANDARD FARBEN

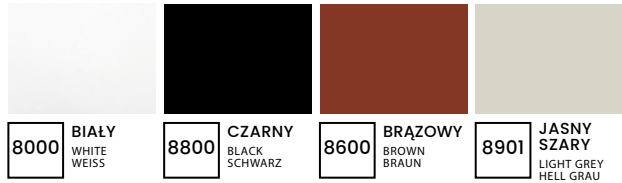

KOLOR Colour   Farbe	F14, F19	8000		
	F15-F16	kolory drewnopodobne		
	F20-F21	kolory jednolite	plain colours	Standard Farben
	F22*	kolory drewnopodobne, 8000, 8800		

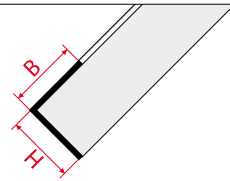

	B	H
F14	15	15
F15	20	20
F16	25	25
F19	10	10
F20	20	10
F21	30	30
F22	40	40

PVC







# EKSPOZYTORY

STANDS | DISPLAYS

## EFFECT 40 TRIO

60 zawieszek | 60 hooks | 60 Anhänger

## EFFECT 60 TRIO

90 zawieszek | 90 hooks | 90 Anhänger

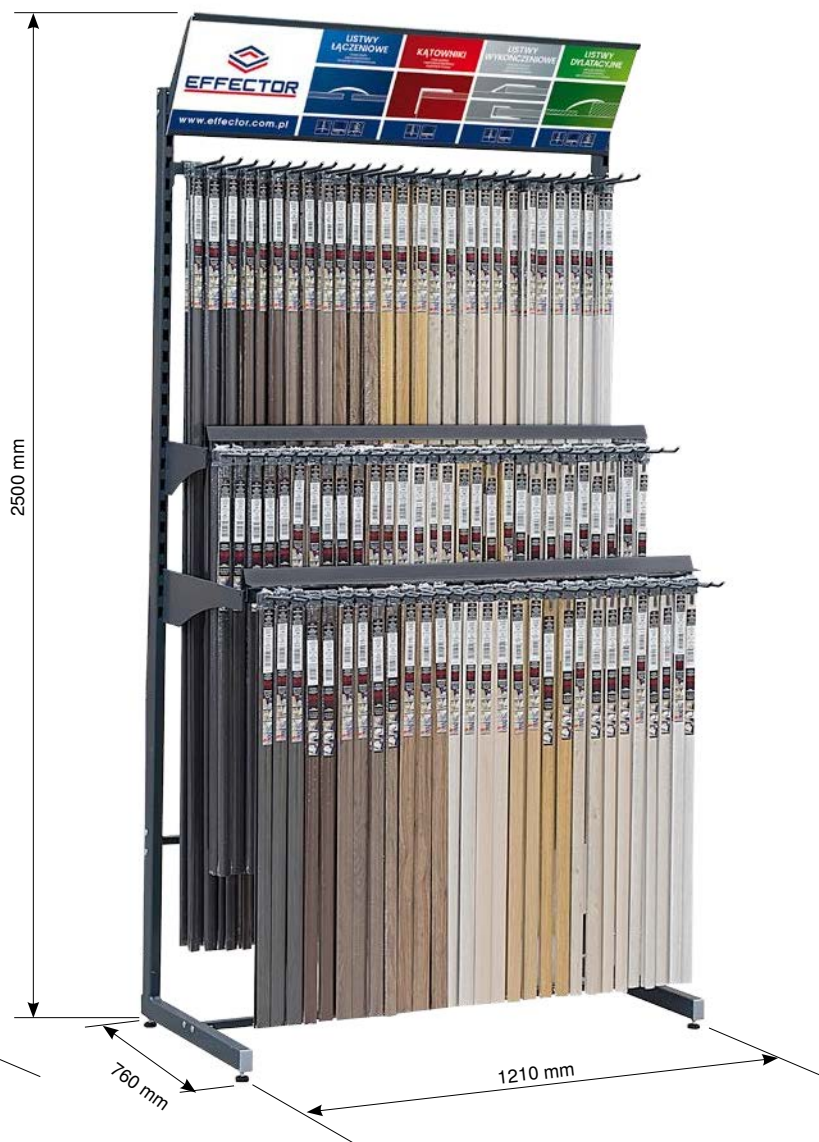



# EFFECTOR MAGO

192 zawieszek | 192 hooks | 192 Anhänger

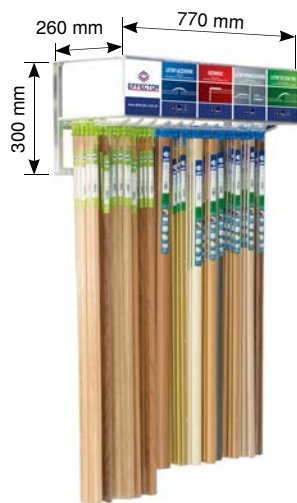

**WIESZAK/HANGER**  
13 zawieszek | 13 hooks | 13 Anhänger

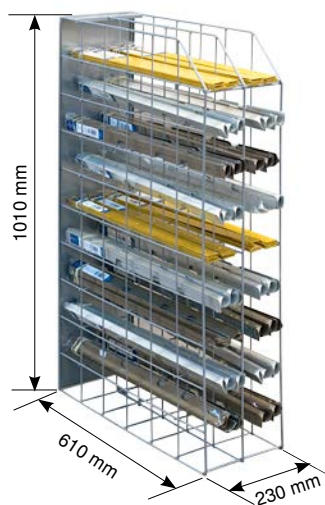

**STOJAK DO LISTEW  
BLATOWYCH**  
TABLE TOP PROFILES EXPOSITOR

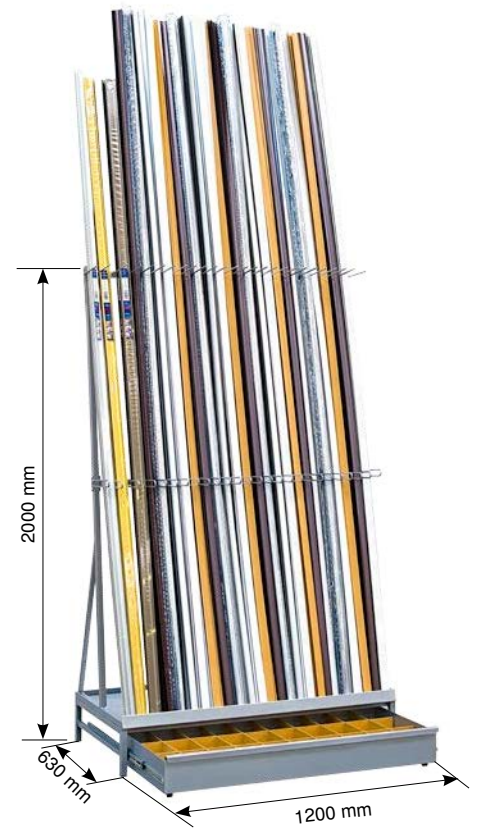

**STOJAK DO LISTEW  
PRZYBLATOWYCH Z SZUFLADĄ**  
TABLE TOP PROFILES EXPOSITOR WITH DRAWER  
25 przegródek | 25 compartments | 25 Fächer



## EFFECT IMPRESJA

25 przegródek | 25 compartments | 25 Fächer



## EFFECT IMPRESJA 80

16 przegródek | 16 compartments | 16 Fächer

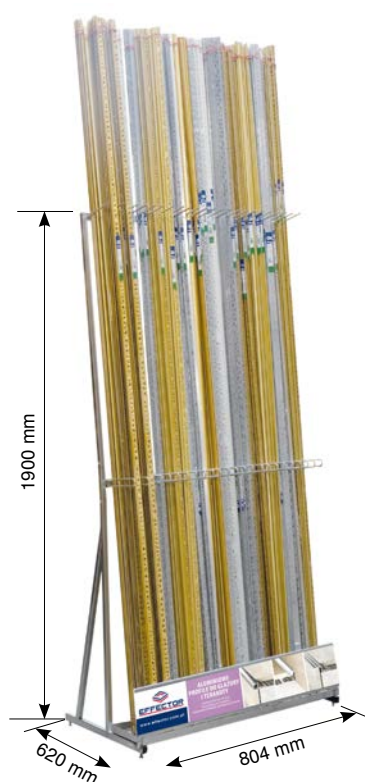

## EFFECT EASY BOX

48 przegródek | 48 compartments | 48 Fächer

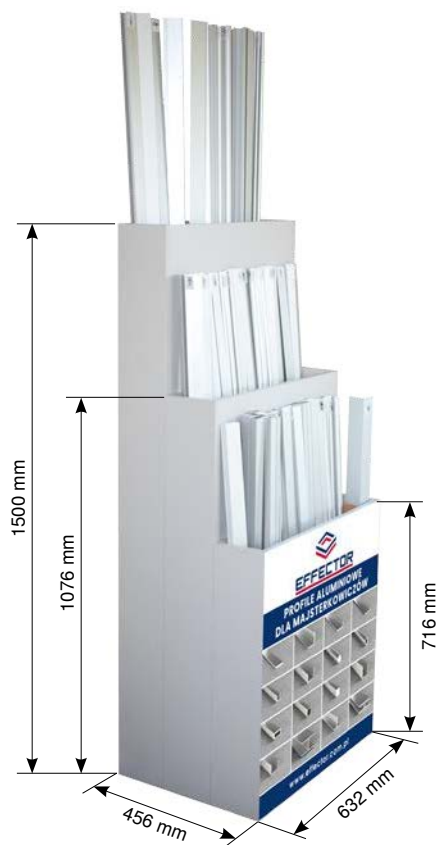

## EFFECT PRAKTYKER

64 przegródek | 64 compartments | 64 Fächer

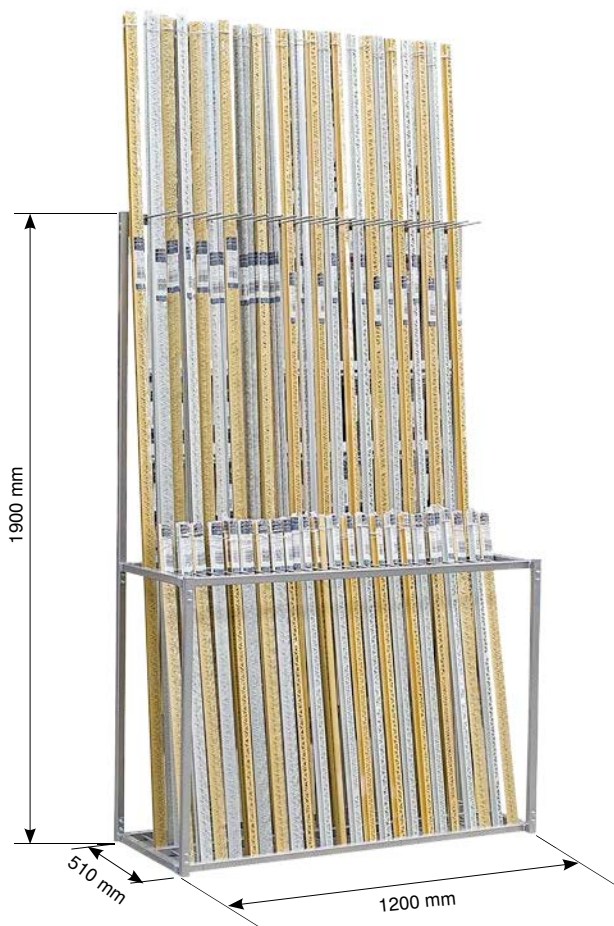

## EFFECT EFFECTA / CLASSIC

17 przegródek | 17 compartments | 17 Fächer



## EFFECT EFFECTA / CLASSIC

Szafki (metalowe) do wykończeń

Metal cabinets for accessories | Metallschränke für Zubehör

	<b>WYMIAR [mm]</b> dimensions   Abmessungen <b>a x b x c</b>	<b>WAGA [kg]</b> weight   Gewicht
<b>10 SZUFLAD - 5X2</b> DRAWERS   SCHUBLADEN	1230 X 455 X 510	50
<b>10 SZUFLAD - 2X5</b> DRAWERS   SCHUBLADEN	510 X 1085 X 510	50
<b>18 SZUFLAD - 6X3</b> DRAWERS   SCHUBLADEN	1280 X 660 X 515	90
<b>20 SZUFLAD - 5X4</b> DRAWERS   SCHUBLADEN	1230 X 880 X 510	100
<b>20 SZUFLAD - 4X5</b> DRAWERS   SCHUBLADEN	990 X 1085 X 510	100
<b>25 SZUFLAD - 5X5</b> DRAWERS   SCHUBLADEN	1230 X 1085 X 510	120
<b>30 SZUFLAD - 5X6</b> DRAWERS   SCHUBLADEN	1230 X 1300 X 510	150



Katalog stanowi informację handlową i nie może być uznawany za ofertę w rozumieniu art. 66 ust. 1 Kodeksu Cywilnego.  
Stanowi on jedynie zaproszenie do rokowań w rozumieniu art. 71 Kodeksu Cywilnego.  
Ze względu na proces technologiczny druku, kolory przedstawionych produktów mogą różnić się od oryginału.



[www.effector.com.pl](http://www.effector.com.pl)



**EFFECTOR S.A.**

29-100 Włoszczowa, ul. Młynarska 29, POLSKA/POLAND

tel. +48 41 39 42 799, fax +48 41 39 45 120

e-mail: [listwy@effector.com.pl](mailto:listwy@effector.com.pl)

e-mail: [export@effector.com.pl](mailto:export@effector.com.pl)